

Space, Shape and Position



Name _____

Series E – Space, Shape and Position

Contents

Topic 1 – Lines, angles and shapes (pp. 1–9)

Date completed

- parallel and perpendicular lines _____
- angles _____
- polygons and quadrilaterals 1 _____
- types of quadrilaterals _____
- polygons and quadrilaterals 2 _____
- symmetry _____
- symmetrical challenges – *create* _____

Topic 2 – Investigating 3D shapes (pp. 10–17)

- properties of shapes _____
- drawing 3D shapes _____
- different viewpoints _____
- cross sections _____
- nets _____
- dice puzzle – *solve* _____
- painted cube – *solve* _____

Topic 3 – Position (pp. 18–24)

- describing position _____
- following directions _____
- grids and coordinates _____
- using a map _____
- compass directions _____
- hit the points – *apply* _____

Series Author:

Nicola Herringer

Lines, angles and shapes – parallel and perpendicular lines

Parallel lines are always the same distance away from each other at any point and can never meet. They can be any length and go in any direction.

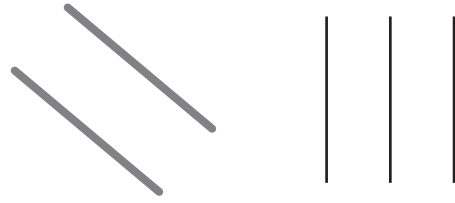

1 Look at each group of lines. Trace over any parallel lines with a coloured pencil:

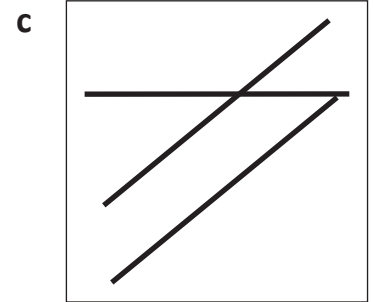
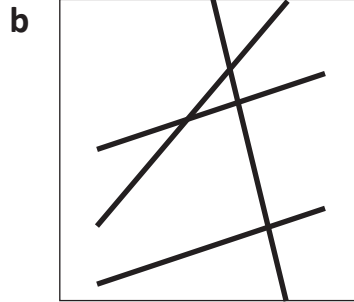
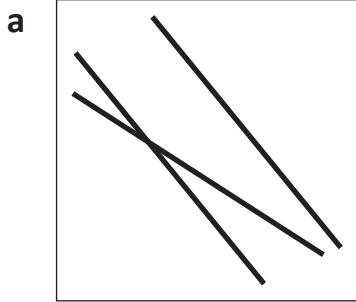

Perpendicular lines meet at right angles. Sometimes they intersect (cross over), sometimes they do not intersect.

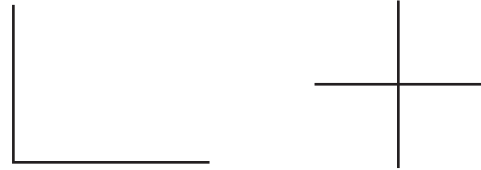

2 Trace each pair of perpendicular lines with a coloured pencil:

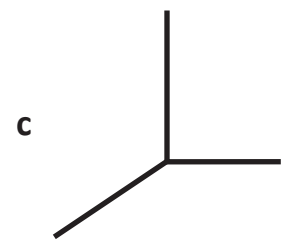
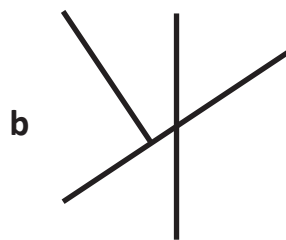
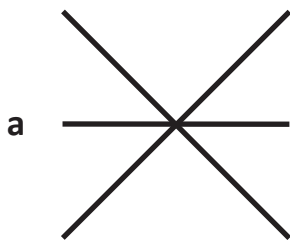

3 In this space, draw three pairs of parallel lines and three pairs of perpendicular lines:



Lines, angles and shapes – angles

An angle is the amount of turning between two lines that meet.

There are three classifications of angles depending on their size.

A right angle is 90° (degrees).

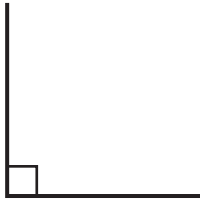

An acute angle is smaller than a right angle.

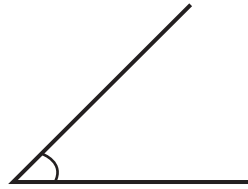

An obtuse angle is larger than a right angle.



1 Classify each angle as right, acute or obtuse.

a

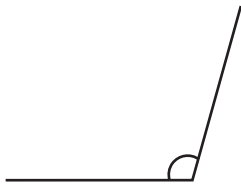

b

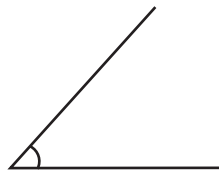

c

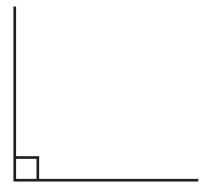

d

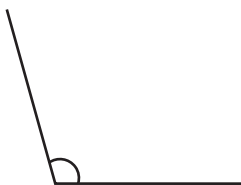

e

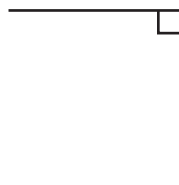

f

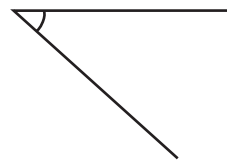

2 Draw hands on each clock that show a time for each type of angle.

a Right angle

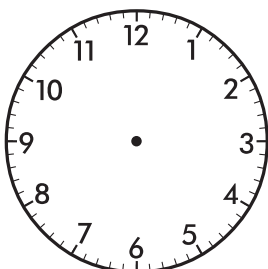

b Obtuse angle

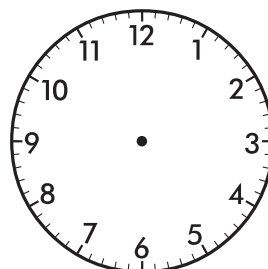

c Acute angle

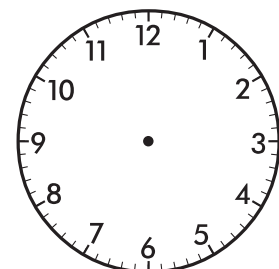

Lines, angles and shapes – angles

3 Use your ruler to draw three more examples of each type of angle.

a Right angles



b Acute angles



c Obtuse angles



4 Complete each closed shape according to the directions:

Shape **a** has 2 acute angles.

Shape **b** has 5 right angles.

Shape **c** has 2 acute and 2 obtuse angles.

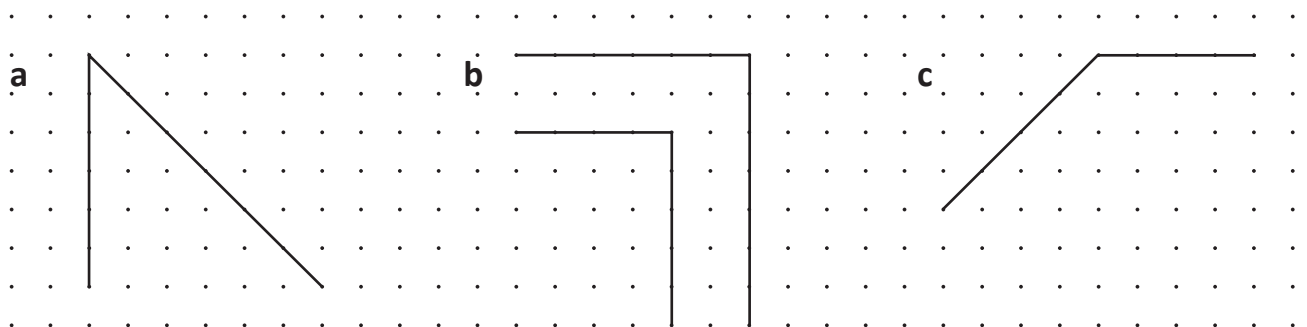

Lines, angles and shapes – polygons and quadrilaterals 1

Polygons are shapes with 3 or more sides.

Quadrilaterals are shapes with 4 sides.

1 Tick the polygons. Circle the quadrilaterals.

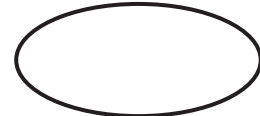
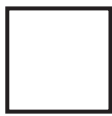
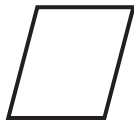
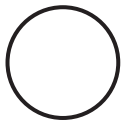

2 Complete this table:

	Name	Number of sides	Number of angles
a	rhombus		
b	pentagon		
c	trapezium		
d	octagon		
e	hexagon		
f	square		
g	rectangle		
h	triangle		

3 Name one shape that is both a quadrilateral and a polygon:

4 Why is a circle not a polygon?

Lines, angles and shapes – types of quadrilaterals

A parallelogram is a quadrilateral with 2 pairs of parallel sides.

This is a parallelogram. Its opposite sides are an equal length and are parallel to each other.



A square and a rectangle are also parallelograms. They have opposite sides that are equal lengths and are parallel to each other.



A rhombus is a parallelogram. Its opposite sides are an equal length and are parallel to each other. It has 4 equal sides.

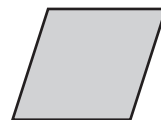

1 How many pairs of parallel lines are there in these parallelograms?

Count them:

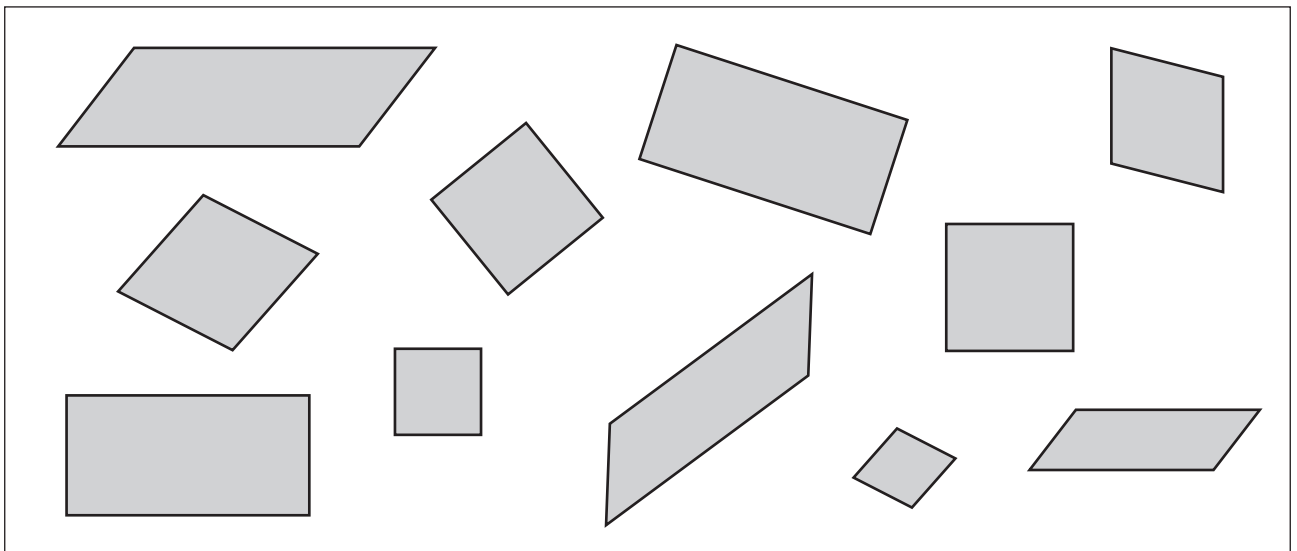

2 Write the number of shapes you can see in the box above.

	Name	Number of shapes
a	rhombuses	
b	squares	
c	rectangles	
d	parallelograms	
e	quadrilaterals	

Lines, angles and shapes – types of quadrilaterals

A trapezium is a quadrilateral and has one pair of parallel sides.

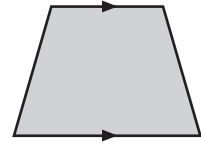

3 Check your understanding of types of parallelograms and trapeziums.

a Draw a shape with two pairs of parallel sides and sides that are equal in length.

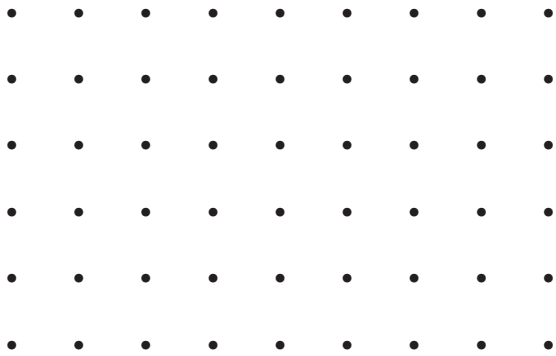

This shape is a _____.

b Draw a shape with one pair of parallel sides.

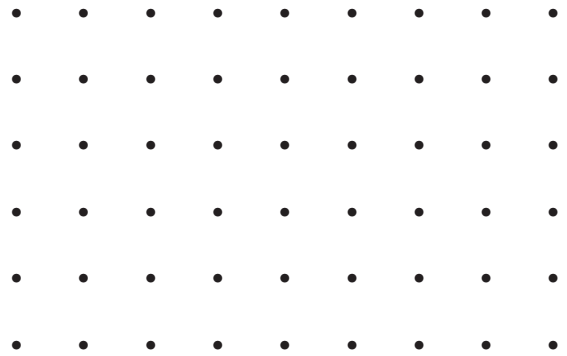

This shape is a _____.

c Draw a shape with two pairs of parallel sides and opposite sides that are equal.

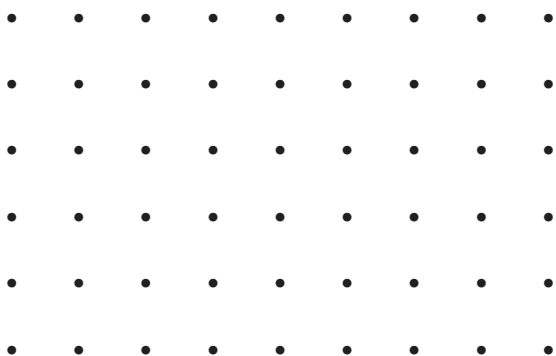

This shape is a _____.

d Draw another parallelogram that is different to the others.

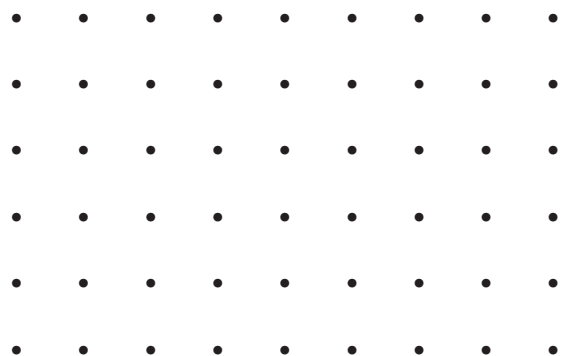

This shape is a _____.

Lines, angles and shapes – polygons and quadrilaterals 2

1 Decide whether each shape in the table is a quadrilateral or a polygon or both. Write yes or no.

	Name	Quadrilateral	Polygon
a	square		
b	rectangle		
c	hexagon		
d	octagon		
e	pentagon		
f	triangle		

2 Draw lines to connect the shapes to the labels. Then put a tick in the shapes which are quadrilaterals and circle the parallelograms. The first one has been done for you.

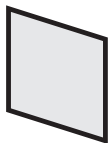
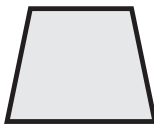
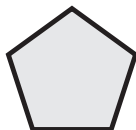
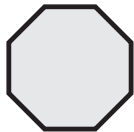
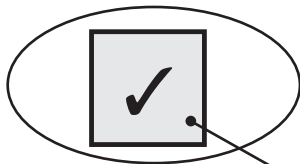

rhombus

square

rectangle

pentagon

hexagon

trapezium

octagon

Some labels might have more than one connecting line.



4 sides

5 sides

6 sides

8 sides

Lines, angles and shapes – symmetry

A shape is symmetrical when you can fold it in half so that one half exactly covers the other half. The fold line is the axis of symmetry. Many 2D shapes have more than one line of symmetry.

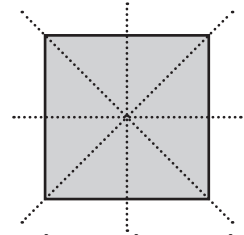

This shape has 4 lines of symmetry.

- 1** Copy this page and cut out each shape. Find all the lines of symmetry. See how many different ways you can fold each shape in half. Then draw in all the lines of symmetry on the shapes on this page.

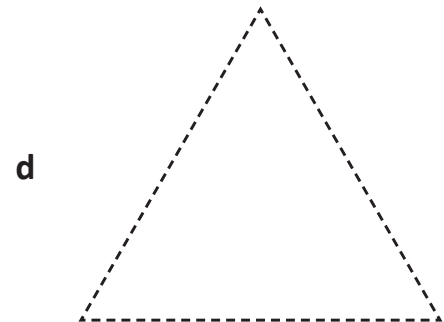
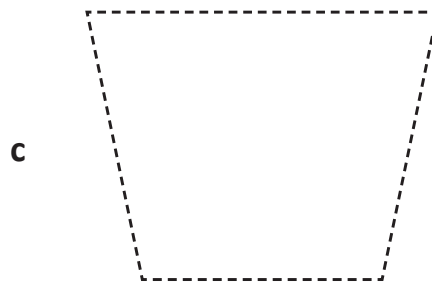
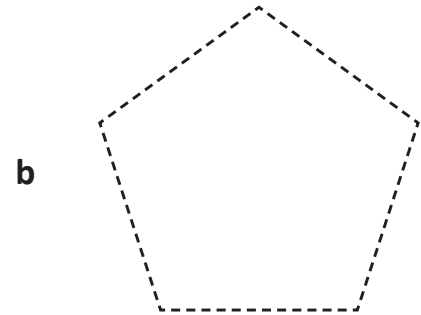
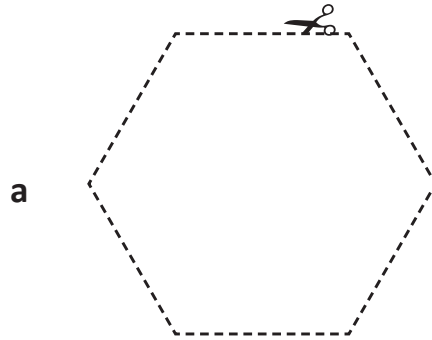

- 2** Use the line of symmetry and a ruler to complete each shape.

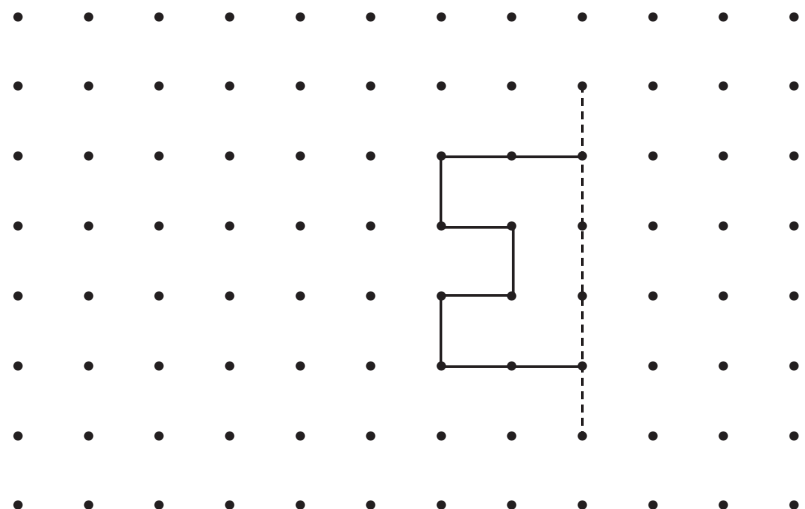
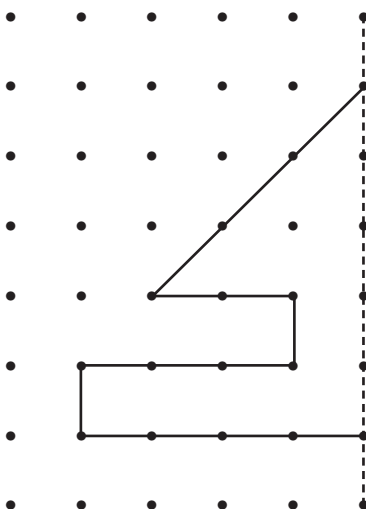

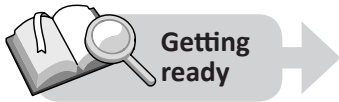

Getting ready

For these challenges, you will need a ruler and a pencil.



What to do

Here are four unfinished symmetrical designs on dot paper. You must complete them. For each design, you must use a horizontal line, a vertical line and two diagonal lines. When they are finished, they will each be symmetrical. For each design, decide where the line of symmetry will be. Pretend the line is a mirror – what will the reflection look like?

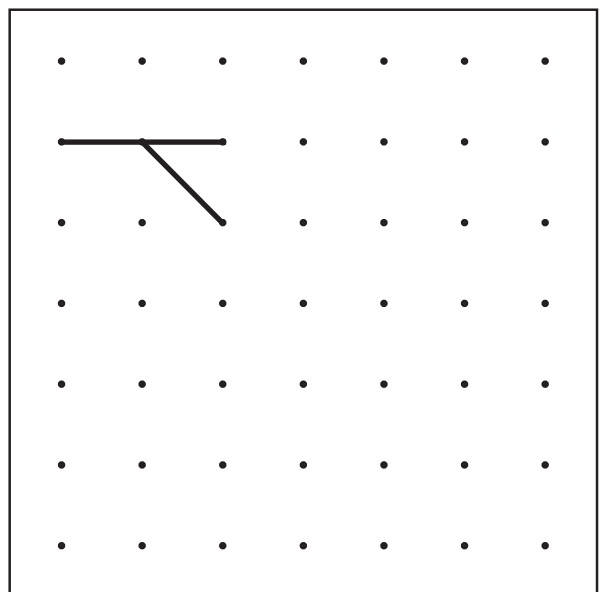
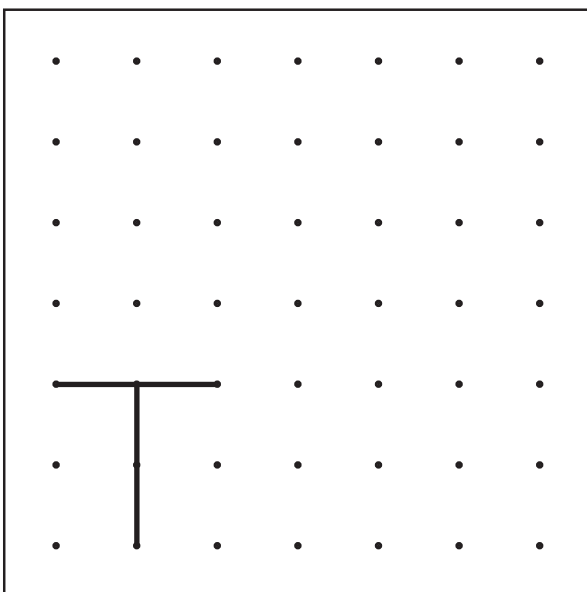
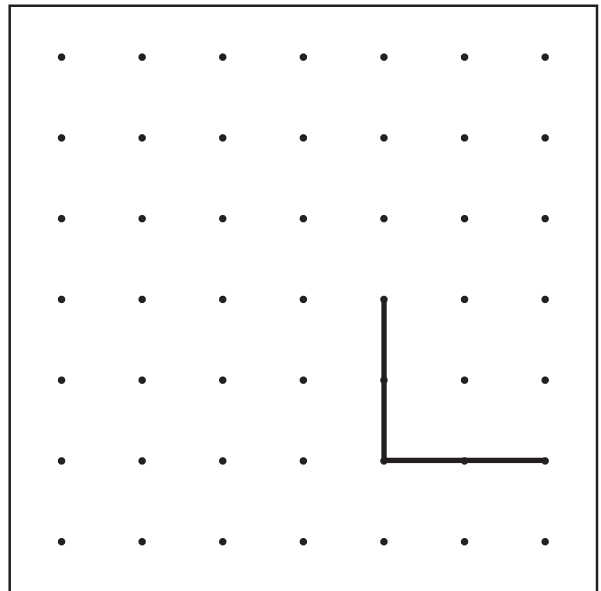
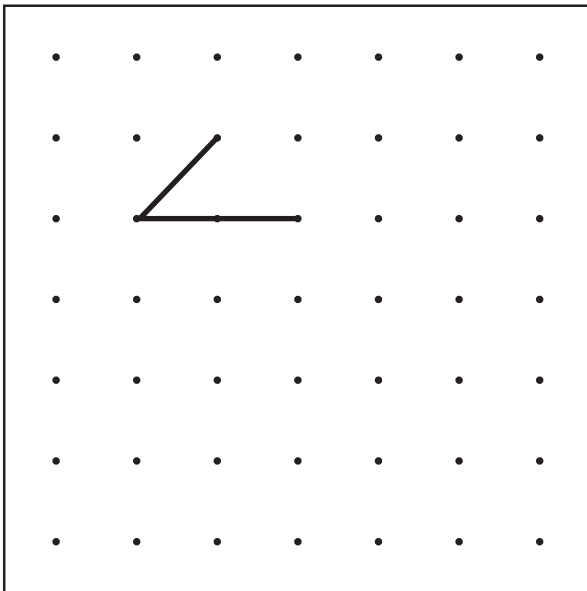

Investigating 3D shapes – properties of shapes

In this topic, we are looking at the properties of 3D shapes. The pointy corner of a 3D shape is called a vertex. The plural is vertices.

Prisms have 2 bases that are the same size and shape and are a type of polygon.

Pyramids have only one base. All the faces are triangular and they meet at a common point also known as the apex.

1 Complete the properties of these prisms:

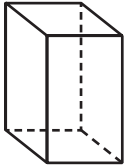
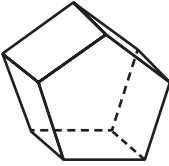
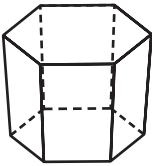
	a 	b 	c 
Name			
Faces			
Vertices			
Edges			

2 Complete the properties of these pyramids:

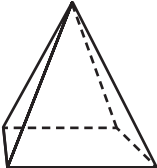
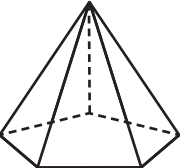
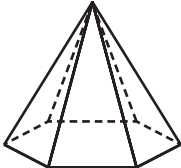
	a 	b 	c 
Name			
Faces			
Vertices			
Edges			

3 Mahlia made a 3D shape using toothpicks and plasticine. She used nine toothpicks and six pieces of plasticine. Circle the shape she made.

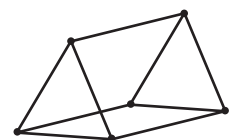
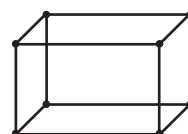

Investigating 3D shapes – drawing 3D shapes

We can draw 3D shapes easily by using dot paper.

Example 1

For a front view, use square dot paper.

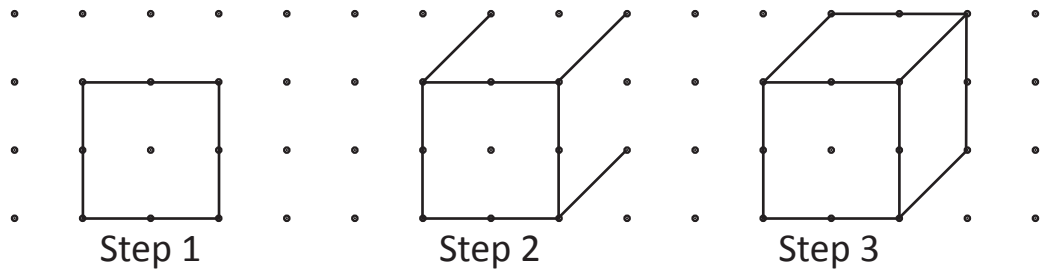

1 Draw these shapes on the dot paper below. You might like to try a few times.

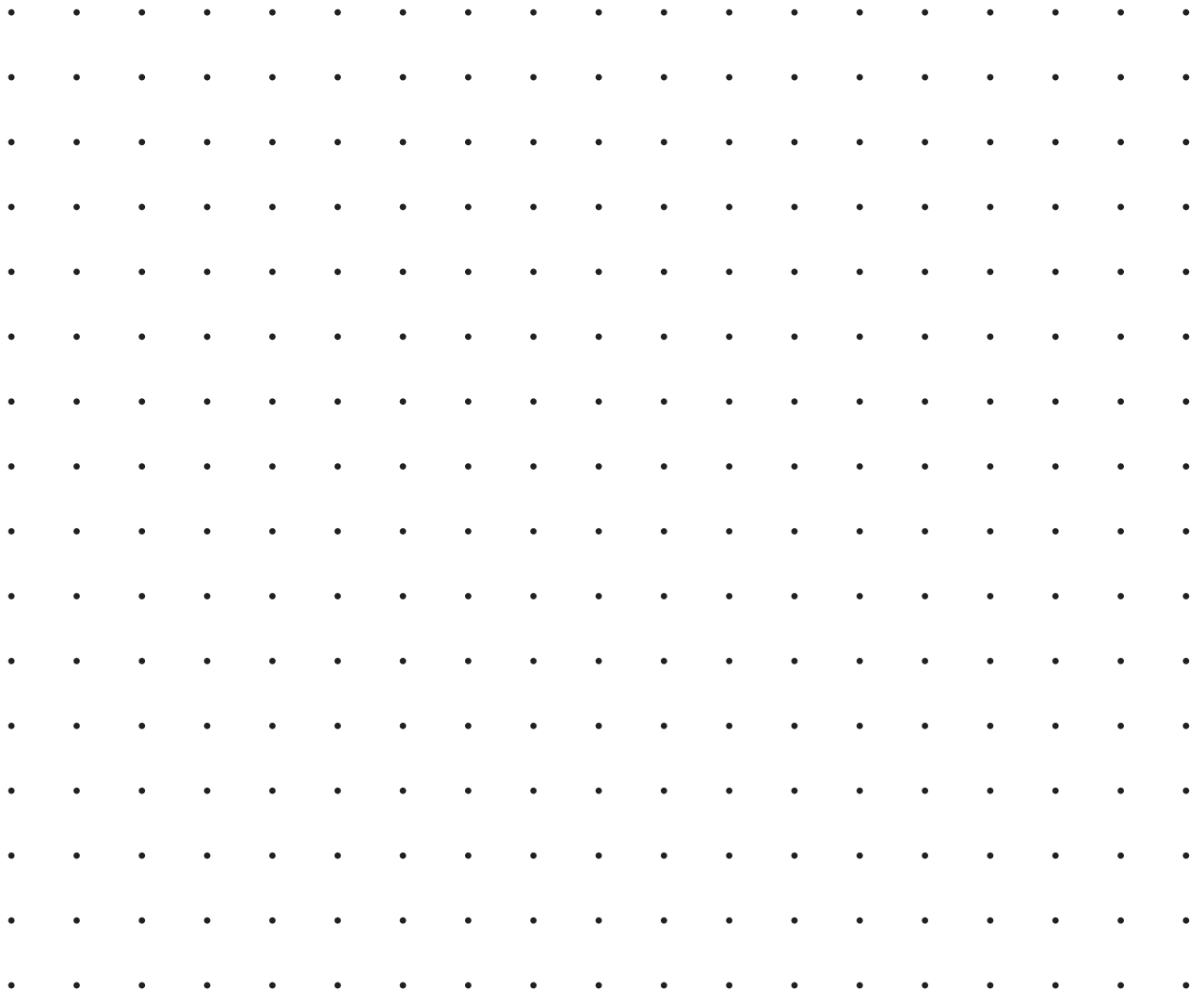
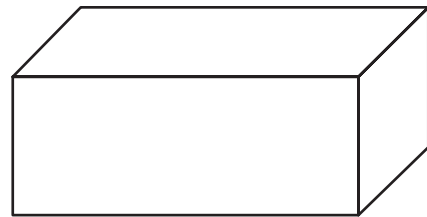
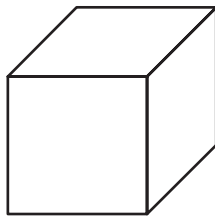

Investigating 3D shapes – drawing 3D shapes

Example 2

For a corner view, use triangular dot paper.

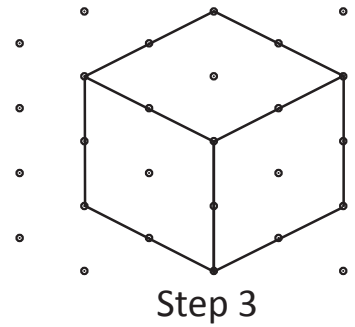
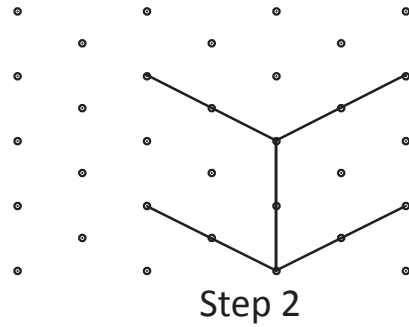
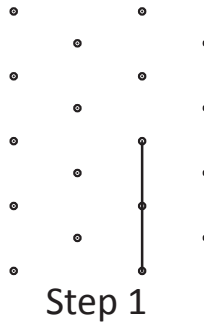

2 Draw these shapes below:

a

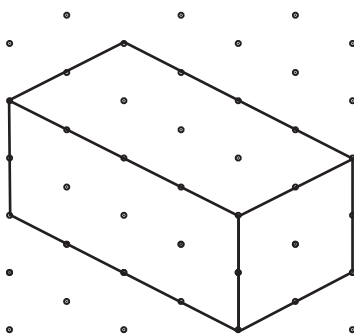

b

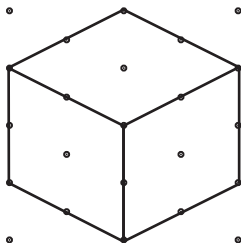

c

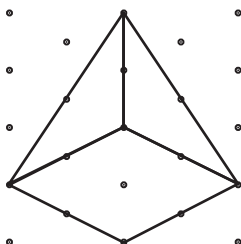

Investigating 3D shapes – different viewpoints

- 1 Here are some 3D models made from cubes. Shade in the squares on each grid to show the top, front and side view for each one. The top view of the first model has been done for you.

a

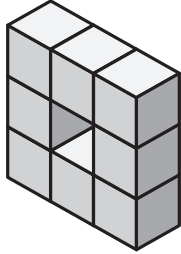

Top view

Front view

Side view

b

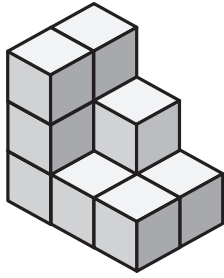

Top view

Front view

Side view

c

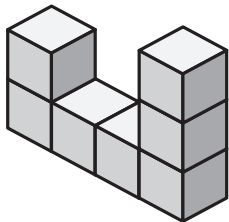

Top view

Front view

Side view

d

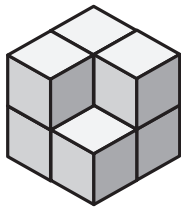

Top view

Front view

Side view

Investigating 3D shapes – cross sections

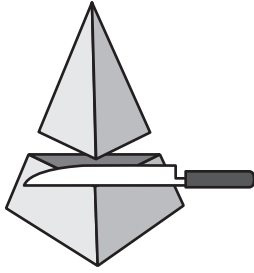

A cross section is what you see when you slice right through something.

1 Draw the cross section next to each shape:

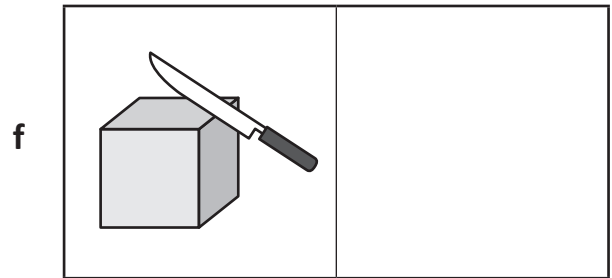
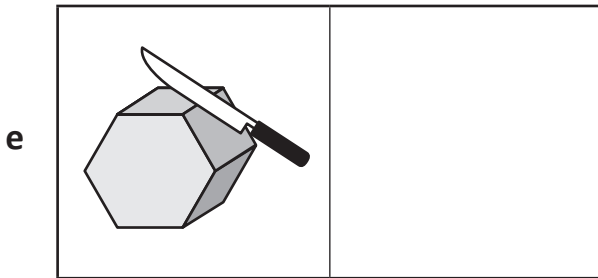
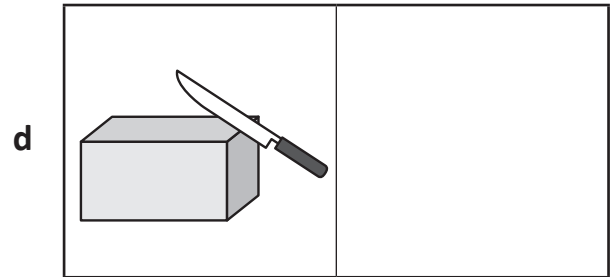
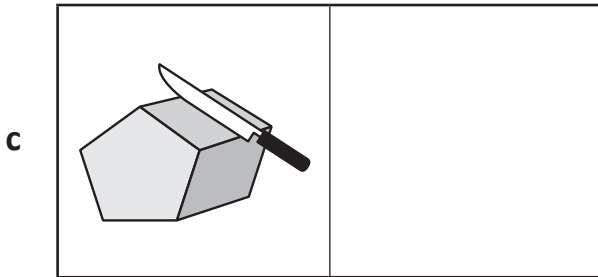
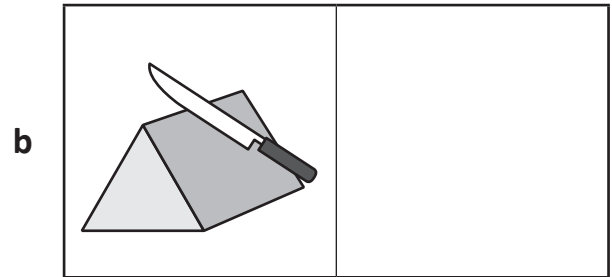
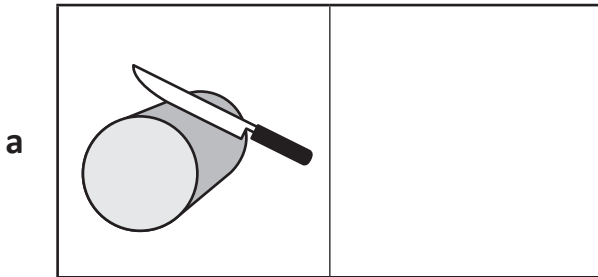

2 Draw a line on each shape to show where you would cut to get the smallest possible circle.

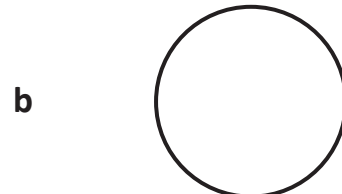
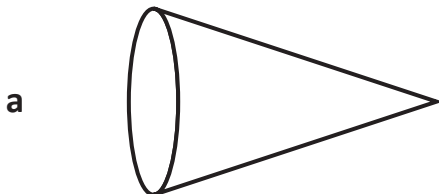

Investigating 3D shapes – nets

A net is the flat shape that a 3D shape can be constructed from.



1 Draw a line to match these 3D shapes with the nets below:

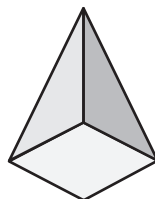
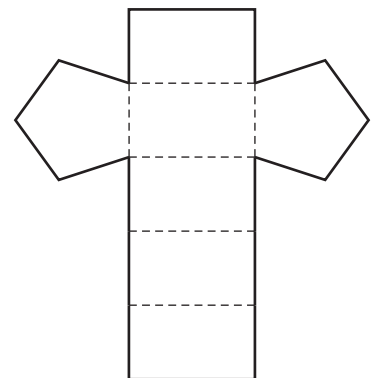
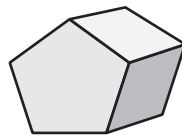
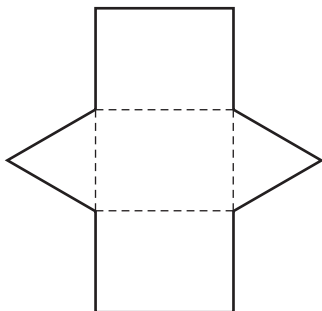
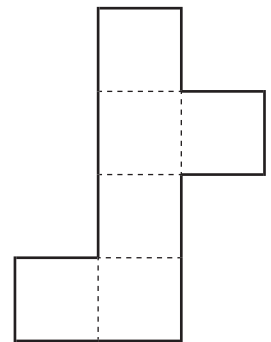
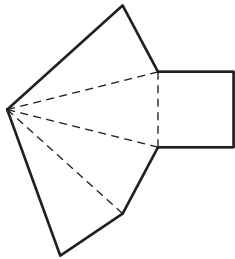
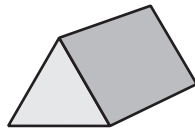
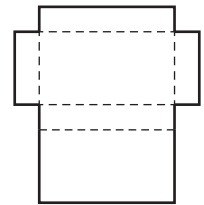
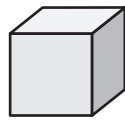
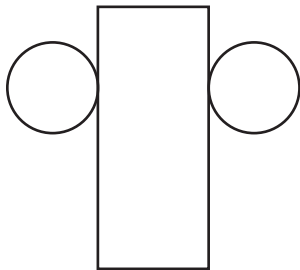

2 Which of these nets will fold into a cube? You may like to ask your teacher to copy this page and enlarge the nets below so you can investigate. Tick the nets that work and cross the nets that don't.

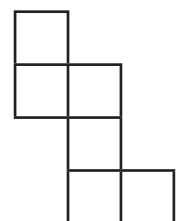
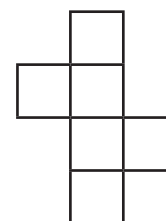
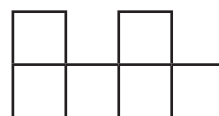
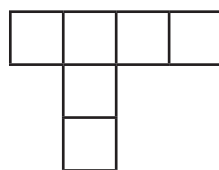
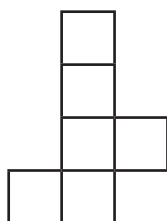
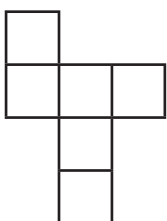



Getting ready

In these two dice puzzles, you have to use the clues to imagine which face has which number.



What to do

Dice Puzzle 1

Write the numbers 1 to 6 on this net of the cube if:

- a 2 is opposite 6.
- b 3 is opposite 5.
- c 1 is opposite 4.

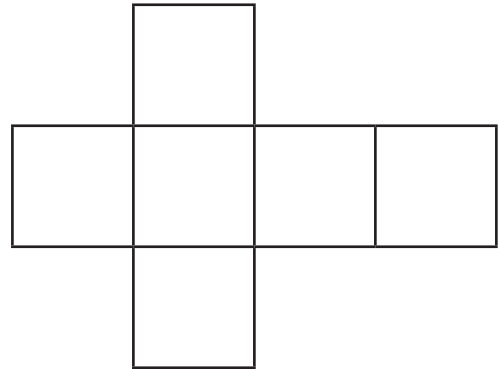

Dice Puzzle 2

Chelsea made a die from a cardboard net of a cube. She puts sticker dots to represent the numbers on each side of the cube.

Here is her cube shown in three different positions. Each time a different number is facing the front.

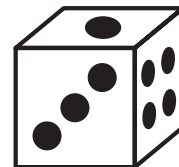
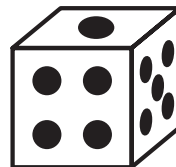
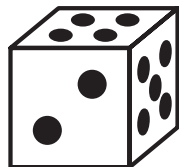

Can you work out which number is on the opposite faces to these?





Getting ready

Matilda built a cube from 27 smaller cubes. She then dipped the large cube in blue paint. When it was completely dry, she broke it up into the smaller cubes.



What to do

Use the table below to predict the following:

- a How many small cubes have three faces covered with paint?
- b How many small cubes have two faces covered with paint?
- c How many small cubes have one face covered with paint?
- d How many small cubes have no faces covered with paint?

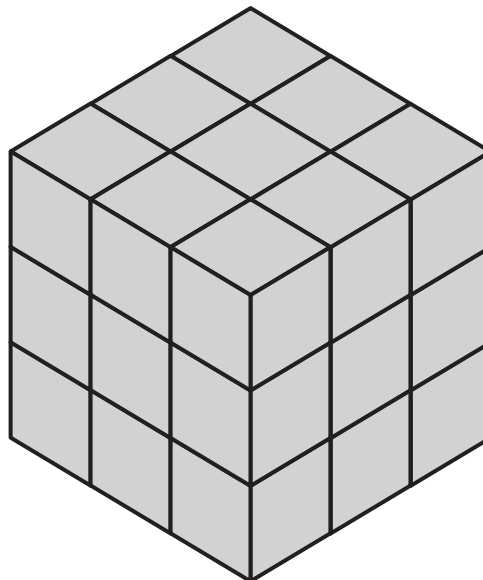

Number of faces covered in paint	Number of small cubes
3	
2	
1	
0	
Total	

Position – describing position

When we use terms such as left and right, where we are in relation to the object changes.

1 Look carefully at each person's position and circle either left or right in each sentence:

- a The grapes are on the left / right of Roger.
- b The cupcakes are on the left / right of Jo.
- c The sandwiches are on Lily's left / right.
- d The jug is on Rachel's left / right.
- e Jo is sitting on the left / right of Lily.
- f Roger is sitting on the left / right of Rachel.

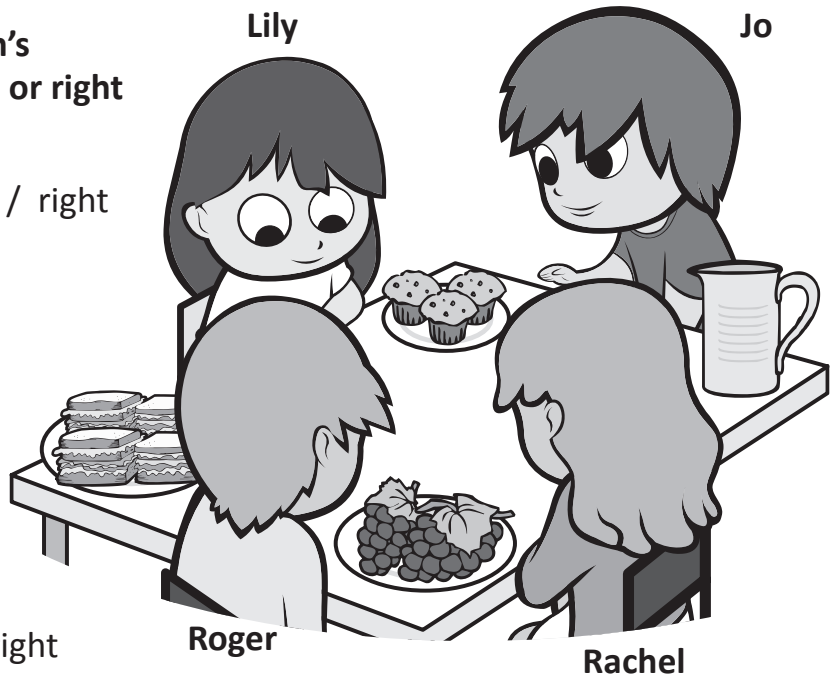

2 Solve this riddle:

What is so fragile that even saying it out loud can break it?

a	b	c	d	e	f	g	

A	L	F	G	C
H	M	P	I	B
E	O	X	E	J
R	W	S	Y	N

- a Bottom row, third column from left.
- b Third row from bottom, second column from right.
- c Top row, second column from left.
- d Second row from bottom, first column.
- e Bottom row, column on far right.
- f Top row, column on far right.
- g Second row from bottom, first column.

Position – describing position

3 Write the names of each student according to Miss Flenley’s seating plan:

- a Josh is in front of Rachel.
- b Emily is in front row second from the right.
- c Karl is behind Emily.
- d Liam is in middle row on the far right.
- e Bec is on Emily’s left.
- f Gina is behind Karl.
- g Megan is between Josh and Karl.
- h Lyn is on Gina’s left.
- i Jo is in front of Megan.
- j Simon is next to Gina.
- k Andrew is in front of Josh.

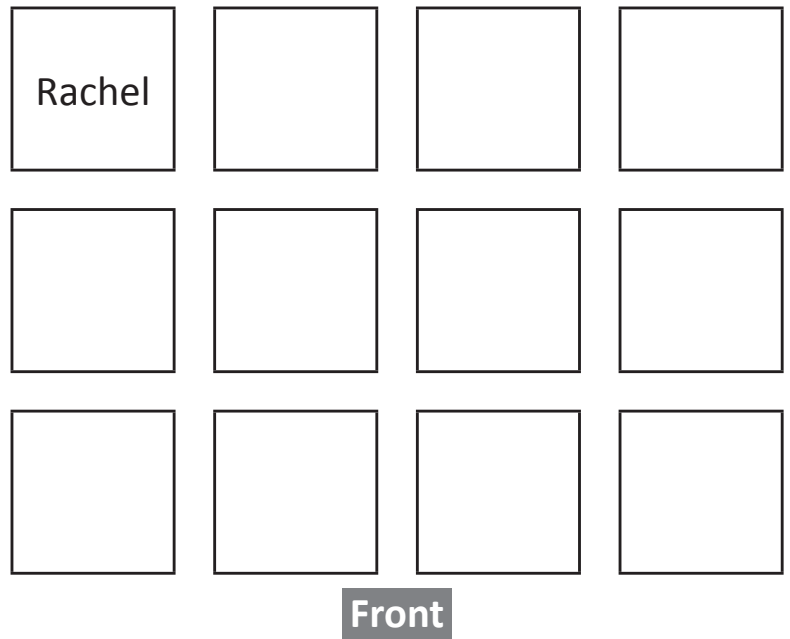

4

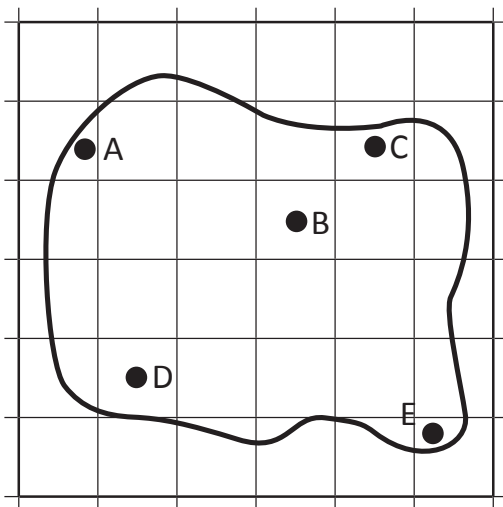

Here is a map showing the best secret hiding spots in a backyard.

- A = Behind the washing line
- B = Behind the garage
- C = Up the tree
- D = Around the side of the house
- E = Next to the recycling bins

Where are these kids hiding? Write the letter.

- a Ellie is row 2, column 2.
- b George is row 1, column 6.
- c Akhil is row 5, column 1.
- d Bri is row 4, column 4.
- e Taylor is row 5, column 5.

Hint: Row 1 is the bottom row.



Position – following directions

On this page, you will practise following the directions **up**, **down**, **left** and **right**.

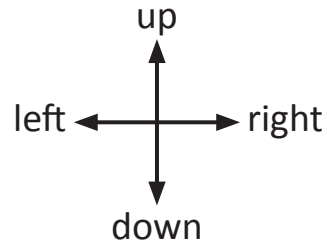

- 1** Three kids are playing a computer game where they have to move through as many stars as possible to get the most points. Colour each player's paths according to the directions below:

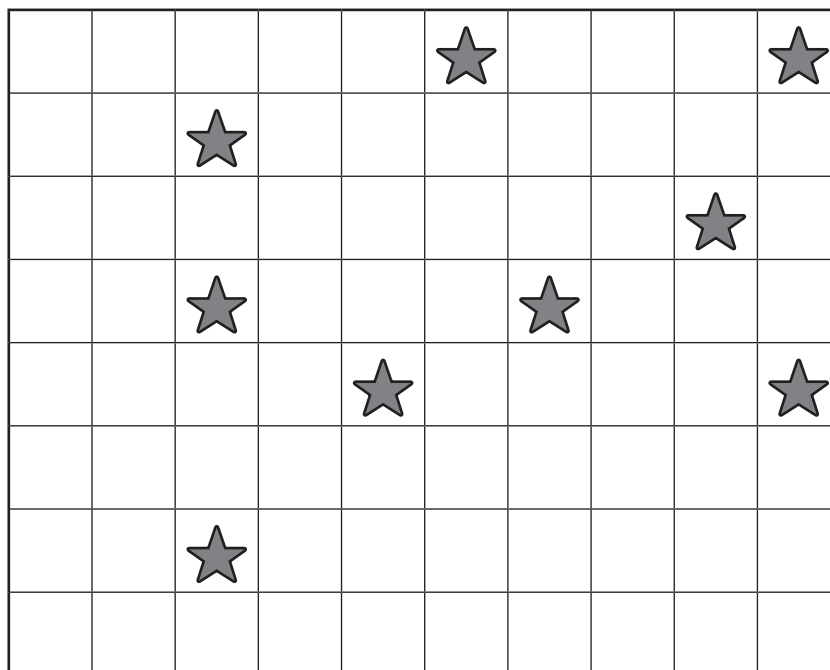

- a** Gemma's path is: Start in the bottom row; 6th square from the left; 1 up; 3 squares left; 6 squares up; and 2 squares left.
- b** Azumi's path is: Start in the 2nd row from the bottom on the right; 2 squares up; 3 squares left; 2 squares up; 3 squares right; and 2 squares up.
- c** Tyler's path is: Start in the bottom row; 1st square on the right; 2 squares left; 2 squares up; 3 squares left; 5 squares up; and 1 square right.
- d** A star is worth 10 points, what was each player's score?

Gemma

Azumi

Tyler

Position – grids and coordinates

Maps are often set up in a grid with letters and numbers down the sides. We use these letters and numbers to pinpoint a particular part of the map.

Sometimes, it is the rows and columns that are labelled.

	A	B	C	D
1				
2				
3		●		
4				

Other times it is the lines that are labelled.

	A	B	C	D
1				
2				
3		●		
4				

1 Answer the questions about what is in each part of the grid.

- a Name the shape at C4. _____
- b Multiply the number at A2 by 3. _____
- c Name the shape at B2. _____
- d Add the numbers at D1 and A1. _____

1	12	●	■	2
2	9	⬡	6	16
3	⬡	5	T	4
4	▲	↓	⬡	8
	A	B	C	D

- e What is different about the shape at B1 compared with the other shapes in this grid?

2 Plot and join the following points. What picture have you made?

- a D1 to A3, A3 to C3, C3 to C7, C7 to E7, E7 to E3, E3 to G3, G3 to D1.

	A	B	C	D	E	F	G	H
1								
2								
3								
4								
5								
6								
7								
8								

Picture: _____

- b E1 to D4, D4 to A4, A4 to C6, C6 to B9, B9 to E7, E7 to H9, H9 to G6, G6 to I4, I4 to F4, F4 to E1.

	A	B	C	D	E	F	G	H	I
1									
2									
3									
4									
5									
6									
7									
8									
9									

Picture: _____

Position – using a map

Here is a map from a street directory. When you learn to drive, you will sometimes use a street directory to find out how to get somewhere that you do not know the directions to.

1 Look carefully at this map and answer the questions below:

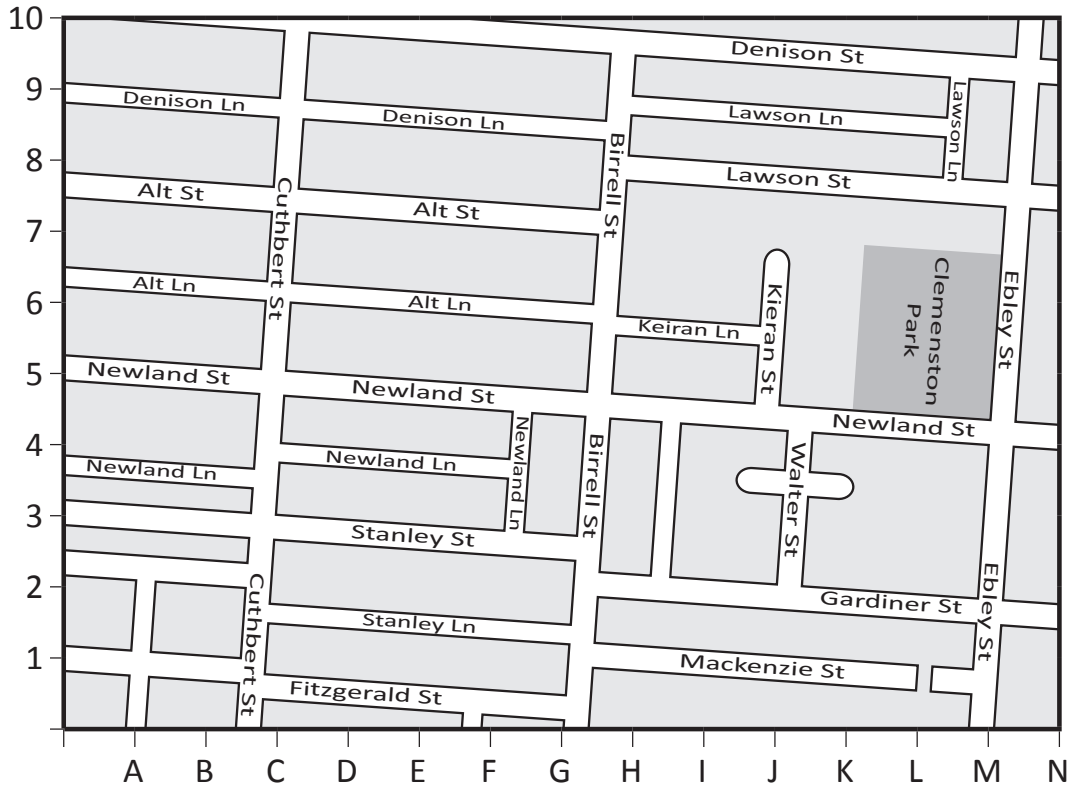

- a Which street is at E4? _____
- b What is parallel to Denison Lane at E8? _____
- c Which street is at J9? _____
- d What are the coordinates that best pinpoint the intersection of Birrell St and Newland St? _____
- e Draw one way to get from the corner of Lawson St and Ebley St to the corner of Cuthbert and Fitzgerald St.
- f Describe how to get to Clemenston Park from B8.

Position – compass directions

We can use a compass to help us with direction.
 There are four main points on a compass:
 N – north S – south E – east W – west
 The points in between the four main points help us describe position more accurately.
 NW – north west NE – north east
 SE – south east SW – south west

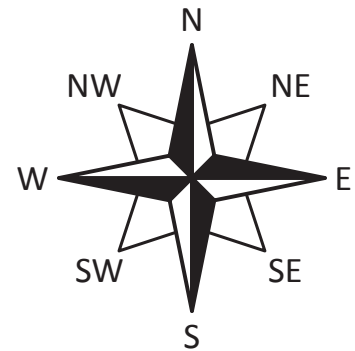

1 On each compass, some directions are missing. Fill in the missing ones:

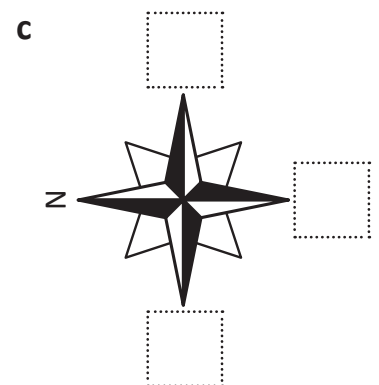
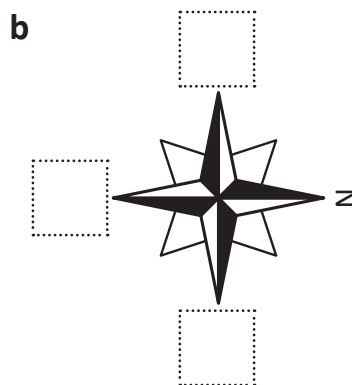
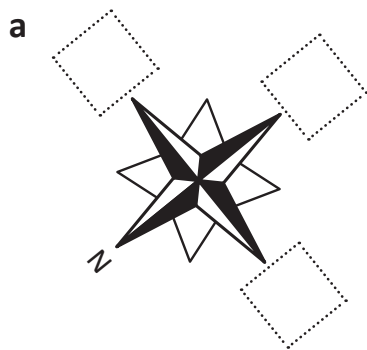

2 Here are four clowns that must find their way to class at circus school. Write the direction that each clown needs to go to get to their class in the spaces below. Take note of where north is.

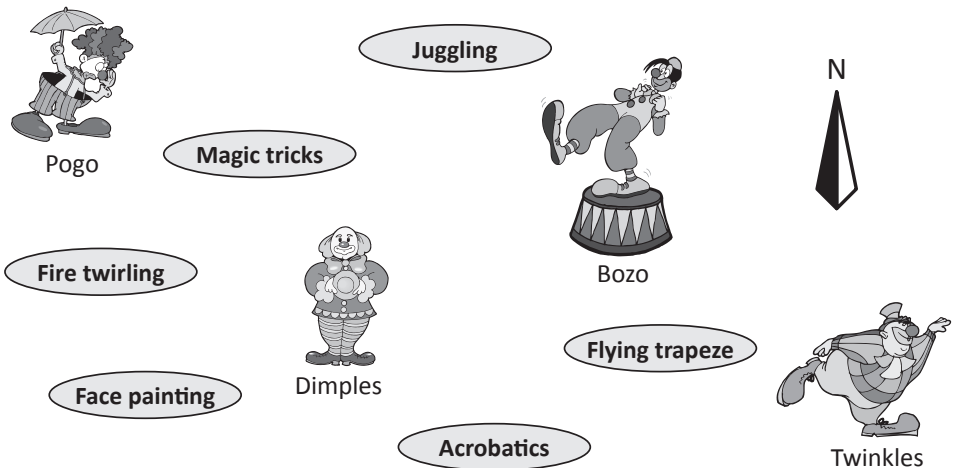

- Pogo is going _____ to the acrobatics class.
- Dimples is going _____ to the juggling class.
- Bozo is heading _____ to the face painting class.
- Twinkles is heading _____ to the magic tricks class.
- Once Twinkles is at the magic tricks class, which direction will he go to get to the flying trapeze class? _____

Hint: Use the points between the four main points.





Getting ready

This is a game for two players. You will need four copies of this page (two grids for each player) and 10 counters.



copy



What to do

Each player places all 10 counters in different positions on their grid without the other player seeing. Take turns to find each other's counters by calling out coordinates. The aim of the game is to find out where all the counters are before the other player does. Don't waste your guesses. Keep track of your guesses by marking them on the second grid.

A											
B											
C											
D											
E											
F											
G											
H											
I											
J											
	1	2	3	4	5	6	7	8	9	10	