

Length, Perimeter and Area

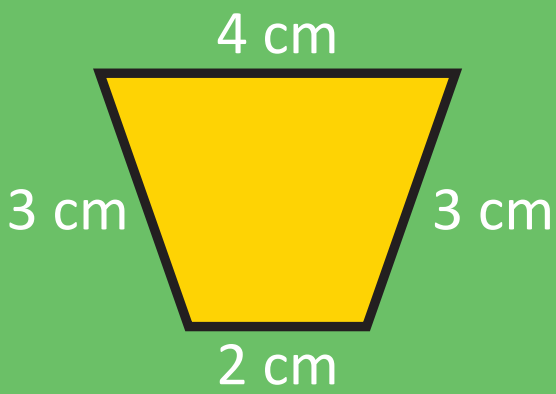

Name _____

Series E – Length, Perimeter and Area

Contents

Topic 1 – Units of length (pp. 1–7)

Date completed

- metres and centimetres _____
- length and decimal notation _____
- millimetres _____
- convert it – *apply* _____

Topic 2 – Perimeter (pp. 8–14)

- measuring shapes _____
- calculating perimeter _____
- perimeter word problems _____
- perimeter challenges – *solve* _____
- harder perimeter challenges – *solve* _____

Topic 2 – Area (pp. 15–22)

- square centimetres _____
- square metres _____
- investigating area and perimeter _____
- area challenges 1 – *apply* _____
- area challenges 2 – *apply* _____

Series Author:

Nicola Herringer

Please note:

These pages have been designed to print to 'shrink to printable area' as this is a common default setting on many computers. There may be minor discrepancies with measurements as individual printers and photocopiers print to slightly different proportions.

Units of length – metres and centimetres

We use metres, centimetres and millimetres regularly in everyday life. There are 100 centimetres in 1 metre. Another way to think about this relationship is that 1 centimetre is one hundredth of a metre.

$$100 \text{ cm} = 1 \text{ m} \quad 1 \text{ cm} = \frac{1}{100} \text{ m or } 0.01 \text{ m} \quad \text{So } \frac{1}{2} \text{ m} = 50 \text{ cm} = 0.5 \text{ m}$$

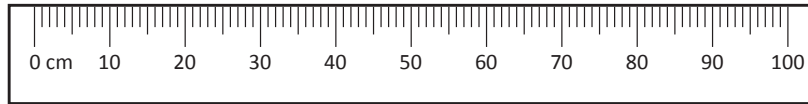

1 Convert each metre measurement into centimetres:

a $2 \text{ m} = \boxed{} \text{ cm}$ b $4 \text{ m} = \boxed{} \text{ cm}$ c $\frac{1}{4} \text{ m} = \boxed{} \text{ cm}$
 d $9 \text{ m} = \boxed{} \text{ cm}$ e $\frac{1}{2} \text{ m} = \boxed{} \text{ cm}$ f $1\frac{1}{4} \text{ m} = \boxed{} \text{ cm}$

2 Convert each centimetre measurement to metres:

a $10 \text{ cm} = \boxed{} \text{ m}$ b $30 \text{ cm} = \boxed{} \text{ m}$ c $90 \text{ cm} = \boxed{} \text{ m}$
 d $50 \text{ cm} = \boxed{} \text{ m}$ e $75 \text{ cm} = \boxed{} \text{ m}$ f $80 \text{ cm} = \boxed{} \text{ m}$

3 Estimate and measure three things that fit in each category:

	Estimate in cm	Measure in cm
a About $\frac{1}{2}$ metre		
b About $\frac{3}{4}$ metre		
c About 1 metre		

4 Match these objects to their correct measurement by connecting them with a line:



37 m 45 cm 5 cm 83 cm 1 m 15 cm 12 cm

Units of length – metres and centimetres

5 Measure the length of the lines below using a ruler. Write each length in centimetres, to the nearest centimetre.

a  cm

b  cm

c  cm

6 Answer these questions about the lines above:

a How much longer is line **b** than line **c**? cm

b What would the length of line **b** be if it was 3 cm shorter? cm

c What would the length of line **c** be if it was 9 cm longer? cm

7 Draw lines for the following measurements. Make sure you start each line on the dot.

a 14 cm •

b $\frac{1}{2}$ cm •

c $8\frac{1}{2}$ cm •

8 Work with a partner to measure the following parts of your body with a tape measure. Label your measurements to the nearest centimetre in the boxes.

a Across your shoulders. cm

c Around one ankle. cm

e From your foot to the top of your thigh. cm

g From the top of your forehead to your chin. cm

b Around your head. cm

d Around one wrist. cm

f Around one knee. cm

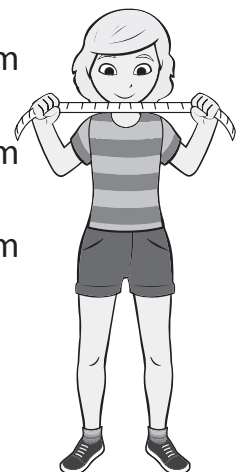

Units of length – length and decimal notation

When we measure things that are in metres and centimetres it is useful to record such lengths in decimal notation. Remember that $1 \text{ cm} = \frac{1}{100} \text{ m}$. This can be written as 0.01 m. So if we measure something that is 1 metre and 36 centimetres long, we would write it like this:

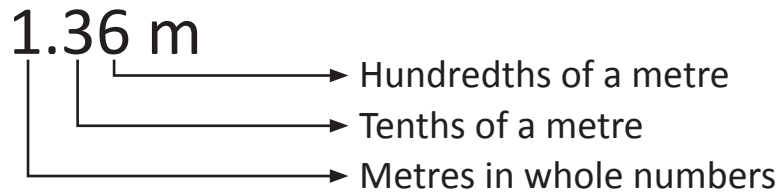

1 Write the measurements in decimal form:

- a 1 metre 69 centimetres = m b 2 metres 91 centimetres = m
c 3 metres 23 centimetres = m d 34 centimetres = m
e 9 metres 4 centimetres = m f 5 metres 9 centimetres = m

2 Write these centimetres as metres using decimal notation:

- a 416 cm = m b 319 cm = m c 567 cm = m
d 607 cm = m e 510 cm = m f 4 cm = m

3 Write these measurements as centimetres:

- a 9.34 m = cm b 3.45 m = cm c 6.07 m = cm
d 5.47 m = cm e 0.94 m = cm f 9.51 m = cm

4 Draw lines for the following measurements. Make sure you start each line on the dot and keep each line parallel to the top of the page.

- a 0.07 m •
b 0.14 m •
c 0.02 m •

Units of length – length and decimal notation

- 5 Charlotte thinks that how far you can jump depends on your height. Do you think she is right? Work in a group of four to complete this table. You will need a tape measure and a space to do long jump. First measure each person's height and record it under their name in decimal notation. Then each person jumps as far as they can. Measure this distance and record it under their height in decimal notation.

Name				
Height				
Long jump				

a Order the names in your group from tallest to shortest:

b Order the long jumps from longest to shortest by writing the names:

c Do you agree with Charlotte? Why or why not?

- 6 Find the lines that connect to make these lengths: 1 m, 2 m and 3 m. Show you have found them by tracing over lines that connect in different colours. To start you off, the first length has been done for you.

a 1 m = _____

b 2 m = _____

c 3 m = _____

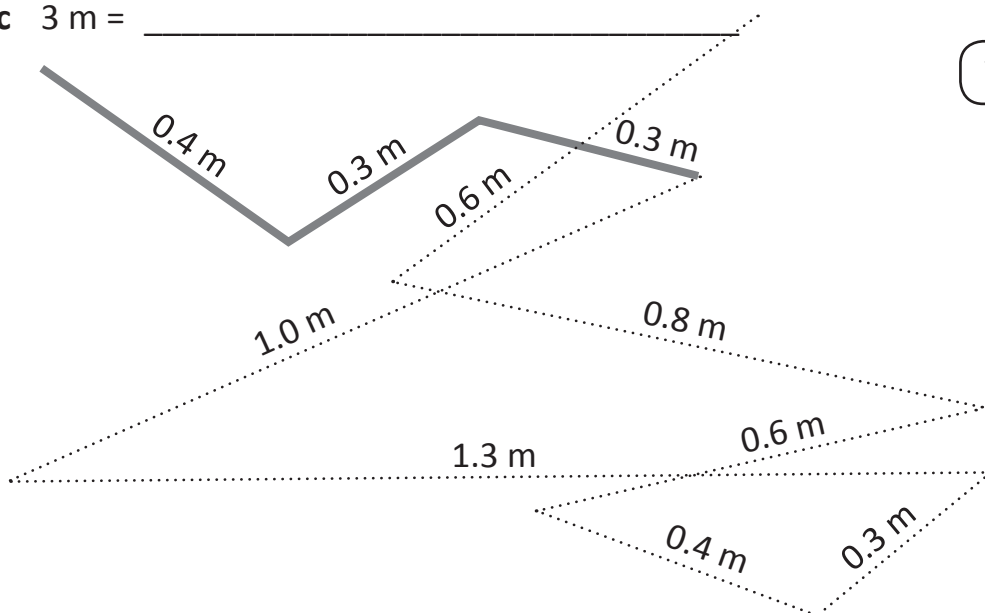

You can use a calculator.



Units of length – millimetres

We use metres, centimetres and millimetres regularly in everyday life. You should learn these millimetre facts:

1 centimetre = 10 millimetres

$$1 \text{ cm} = 10 \text{ mm}$$

$$45 \text{ mm} = 4 \text{ cm } 5 \text{ mm}$$

$$45 \text{ mm} = 4.5 \text{ cm}$$

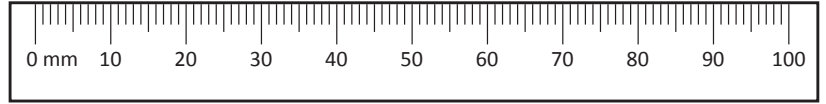

1 Estimate and measure these objects in millimetres:

	Object	Estimate	Millimetres
a	Width of your thumb		
b	Length of your hand		
c	Length of a grape		

2 Convert these centimetre measurements into millimetres:

a $4 \text{ cm} = \square \text{ mm}$ b $3 \text{ cm} = \square \text{ mm}$ c $10 \text{ cm} = \square \text{ mm}$

d $6\frac{1}{2} \text{ cm} = \square \text{ mm}$ e $7 \text{ cm} = \square \text{ mm}$ f $\frac{1}{2} \text{ cm} = \square \text{ mm}$

3 Write these as centimetres and millimetres:

a $17 \text{ mm} = \square \text{ cm } \square \text{ mm}$ b $29 \text{ mm} = \square \text{ cm } \square \text{ mm}$

c $42 \text{ mm} = \square \text{ cm } \square \text{ mm}$ d $36 \text{ mm} = \square \text{ cm } \square \text{ mm}$

4 Write these measurements as centimetres:

a $12 \text{ mm} = \square \text{ cm}$ b $46 \text{ mm} = \square \text{ cm}$

c $63 \text{ mm} = \square \text{ cm}$ d $48 \text{ mm} = \square \text{ cm}$

Units of length – millimetres

5 Follow these steps to measure these lines accurately in centimetres and millimetres.

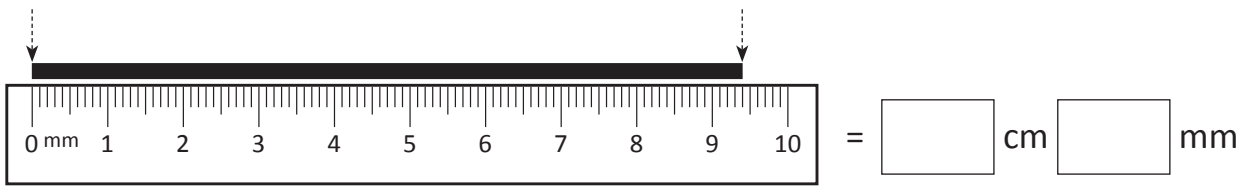

- Line up the zero on your ruler with the start of the line.
- Read the last cm that is at the end of the line.
- Write down the cm number.
- Count the mm after the cm and write it next to the cm.



6 Complete the table for these deadly spiders:

		Length in mm	Length in cm and mm	Length in cm
a	Redback			0.7 cm
b	Funnel web		1 cm and 5 mm	
c	Black widow	13 mm		
d	Brown recluse			2.5 cm

e List these deadly spiders in order from smallest to largest:

Convert it

apply



Getting ready

This is a game for two players. Players need a counter each, a copy of this page and a die.



copy



What to do

The object of this game is to get to the finish line first. Decide who will go first. That player rolls the die and moves that many spaces on the board. If you land on a measurement that is white, you must convert cm to mm OR m to cm. If you land on a measurement that is grey, you must either convert mm to cm OR cm to m. The other players decide if you are correct. If you are, then you move forward 1 space. If you are incorrect, you move backwards 2 spaces.

73	74 $\frac{1}{2}$ cm	75	76 20 cm	77 9.5 m	78	79	80	81 Finish
72	71 150 mm	70	69 7.25 m	68	67	66 7 500 cm	65	64
55 30 cm	56	57	58 350 mm	59	60 0.75 m	61	62	63 $\frac{1}{2}$ m
54	53 5 500 cm	52 16 cm 4 mm	51	50	49 35 cm	48	47	46 920 mm
37 980 mm	38	39 10 cm	40	41	42	43 10.6 cm	44	45 15 cm 2 mm
36	35 250 mm	34	33 75 mm	32 110 mm	31	30	29	28 500 mm
19	20 1 000 cm	21	22 $\frac{3}{4}$ m	23	24	25 $2\frac{3}{4}$ m	26	27 660 mm
18 350 mm	17	16 $5\frac{1}{2}$ cm	15	14 $1\frac{1}{2}$ m	13	12	11 150 cm	10
1 Start	2	3 3 cm	4	5 100 mm	6	7 5 m	8	9 300 cm

Perimeter – measuring shapes

Perimeter is the total length around the outside of an enclosed space.
To find the perimeter of this shape, we add the lengths of all the sides.

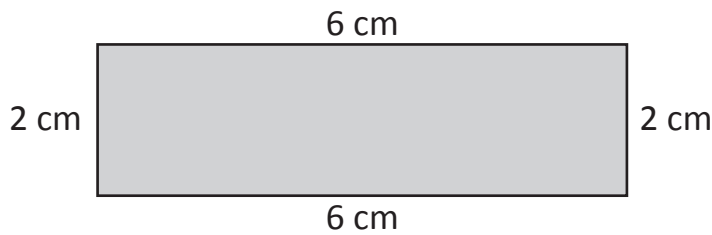

$$P = 6 + 2 + 6 + 2$$
$$= 16 \text{ cm}$$

1 Find the perimeters of these shapes:

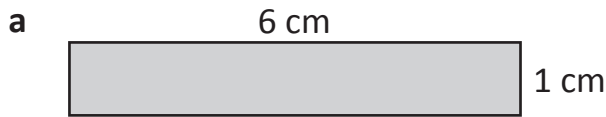

$$P = \underline{\quad} + \underline{\quad} + \underline{\quad} + \underline{\quad}$$
$$= \underline{\quad\quad} \text{ cm}$$

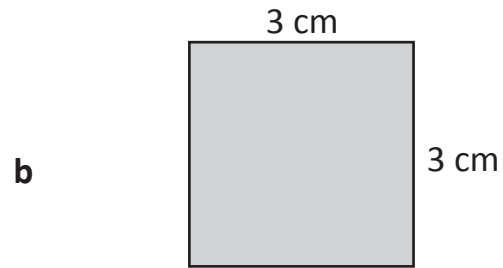

$$P = \underline{\quad} + \underline{\quad} + \underline{\quad} + \underline{\quad}$$
$$= \underline{\quad\quad} \text{ cm}$$

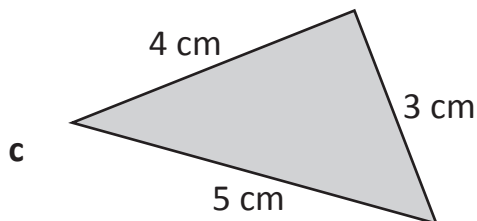

$$P = \underline{\quad} + \underline{\quad} + \underline{\quad}$$
$$= \underline{\quad\quad} \text{ cm}$$

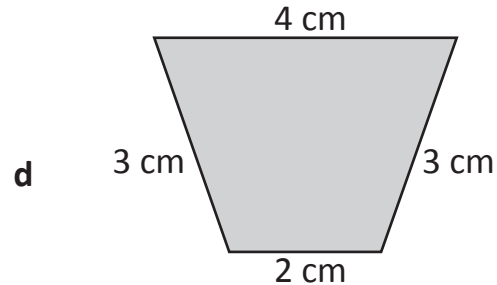

$$P = \underline{\quad} + \underline{\quad} + \underline{\quad} + \underline{\quad}$$
$$= \underline{\quad\quad} \text{ cm}$$

2 Find the perimeter of this shape. Set your working out clearly.

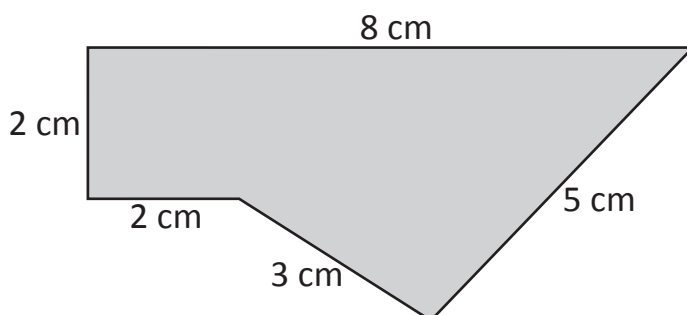

Perimeter – measuring shapes

3 Find the perimeters of these irregular shapes. Use the 1 cm dot paper as your guide.

a

P = _____

b

P = _____

c

P = _____

d

P = _____

e

P = _____

f

P = _____

4 Use a ruler to draw some shapes with the following perimeters. You can experiment first with a geoboard and some rubber bands.

a Draw a rectangle with a perimeter of 12 cm.

b Draw a rectangle with a perimeter of 20 cm.

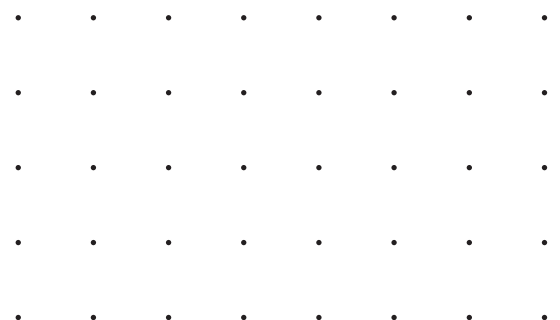
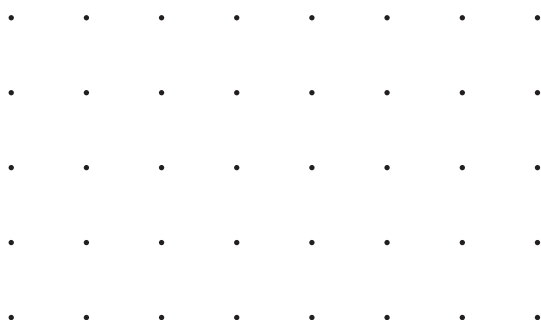

Perimeter – calculating perimeter

- 1** Use what you know about squares and rectangles to work out the perimeter of these shapes. Measuring will not help because they are not to scale. Look carefully at the dimensions.

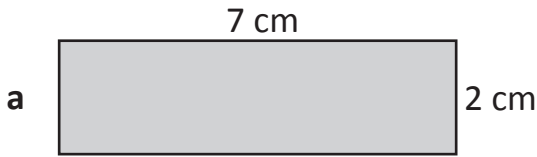

P = cm

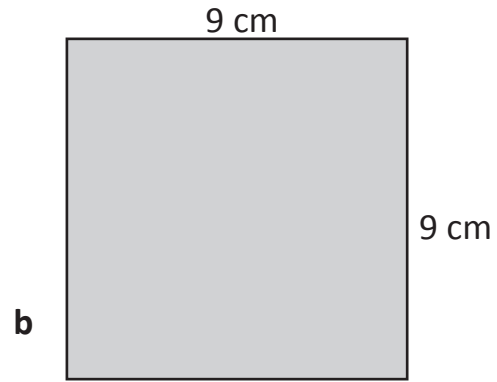

P = cm

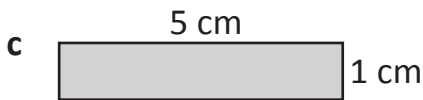

P = cm

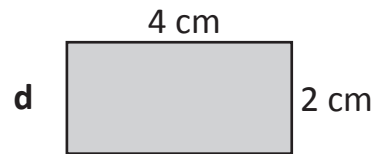

P = cm

- 2** Show how to find the perimeter of these shapes with an addition sentence and a multiplication sentence for each. Shape A has been done for you.

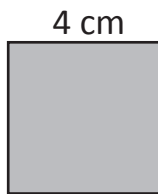

Shape A

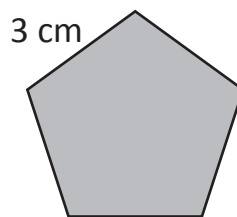

Shape B

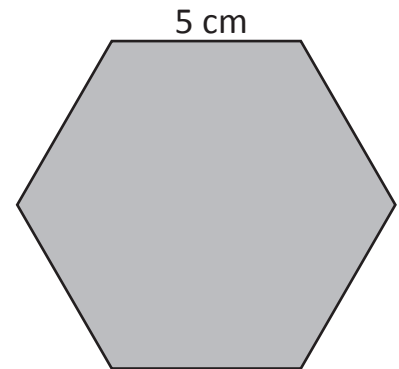

Shape C

Shape	Perimeter by addition	Perimeter by multiplication
A	$4 + 4 + 4 + 4 = 16$ cm	4 sides \times 4 cm = 16 cm
B		
C		

Perimeter – calculating perimeter

3 Predict the perimeter of each of these shapes on the square centimetre grid below. Show what the perimeter is by drawing and labelling.

a A square with 4 cm sides.

P = cm

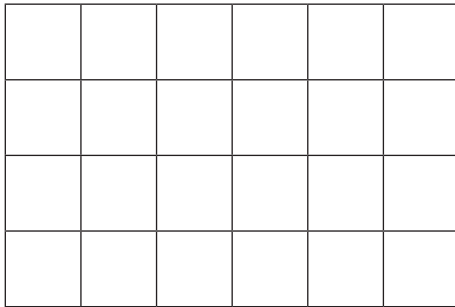

b A rectangle with two 3 cm sides and two 1 cm sides.

P = cm

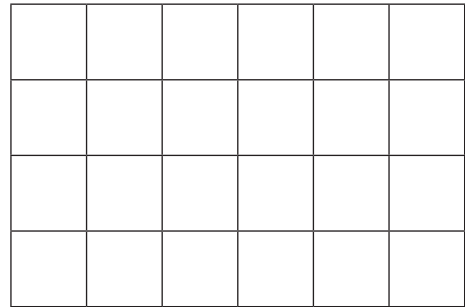

4 Use the 1 cm grid paper to construct the following shapes at each starting point with the stated perimeter.

a 10 cm

b 14 cm

c 8 cm

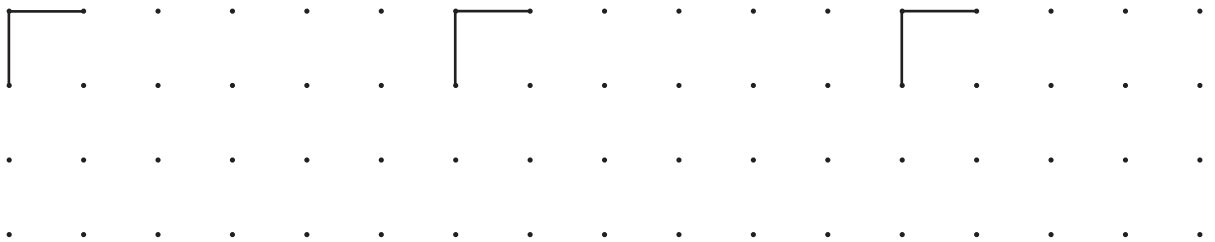

5 Here are more square centimetre grids.

a What is the perimeter of this irregular shape?

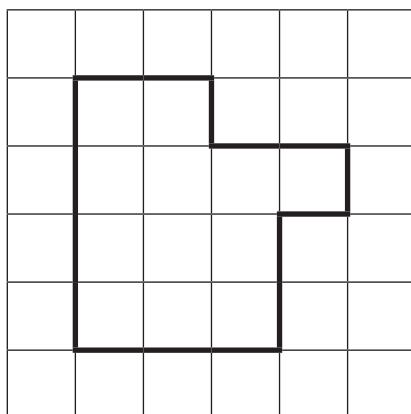

P = cm

b Draw a square with the same perimeter.

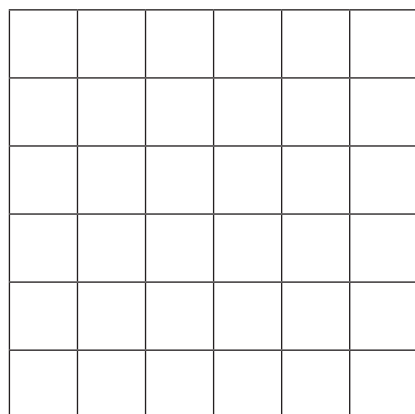

Perimeter – perimeter word problems

1 Solve these perimeter problems:

- a Pablo drew a rectangle in his workbook. The perimeter of the rectangle was 34 cm. Two sides are 12 cm long. How long are the other two sides?

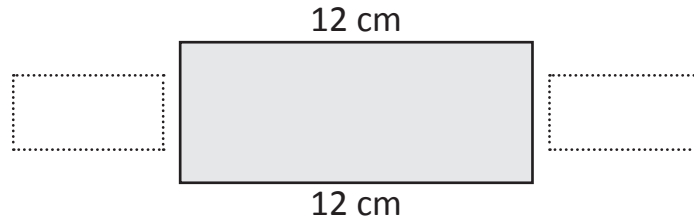

- b The perimeter of a square shaped pool is 100 m. What are the measurements of the pool?

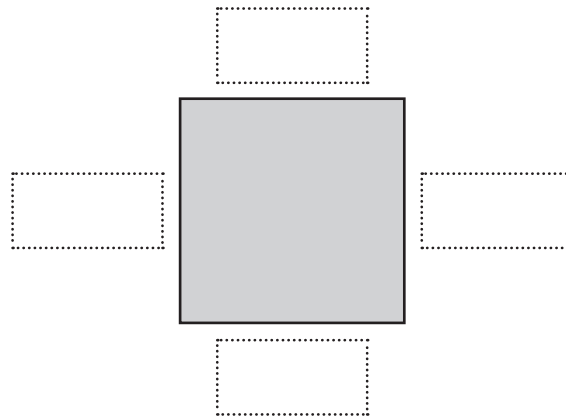

- c West Thyme Primary School is adding a new fence around the outside of the playground. The playground is rectangular shaped. One length is 16 m. The perimeter is 52 m. What are all the measurements of the playground?

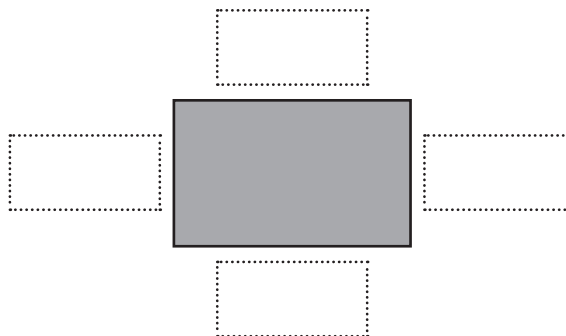

- d Liam made a pentagon from magnetic sticks. If the perimeter of his shape is 55 cm, what is the length of one side?

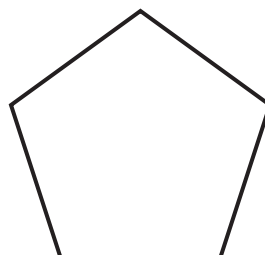

Length of one side =



What to do



Try these perimeter challenges:

- a The perimeter of this square is 32 cm.
When it is cut in half, we get two identical rectangles.
What is the perimeter of one rectangle?

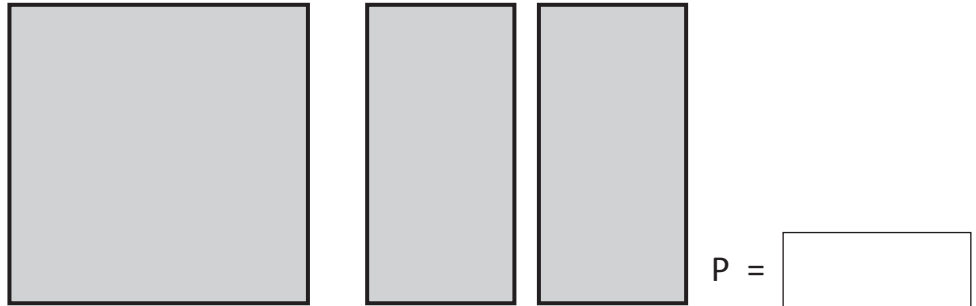

- b This rectangle is 6 cm wide.
How long is it if the perimeter is 32 cm? []

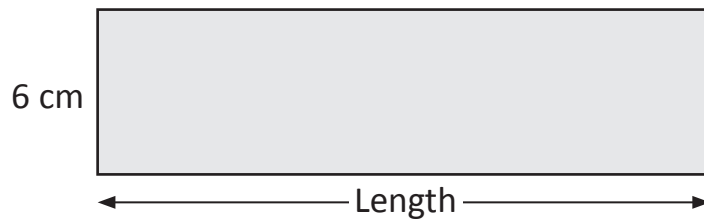

The lines on some of the sides are to show you they are all the same length.



THINK

- c Find the perimeter of this shape if the length is 12 cm.

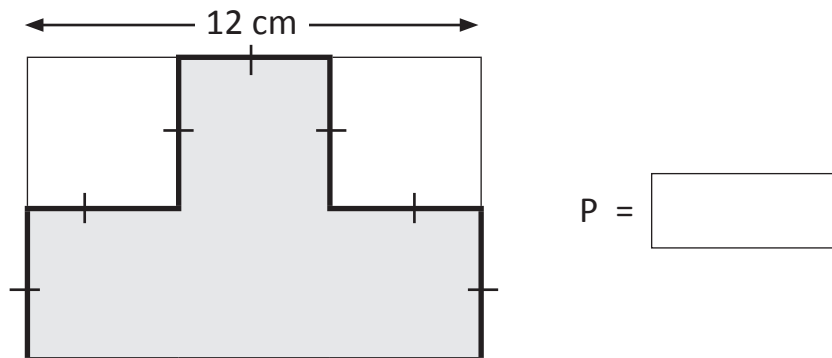



What to do

Use the clues in each of these diagrams to find the perimeter.

Diagram 1

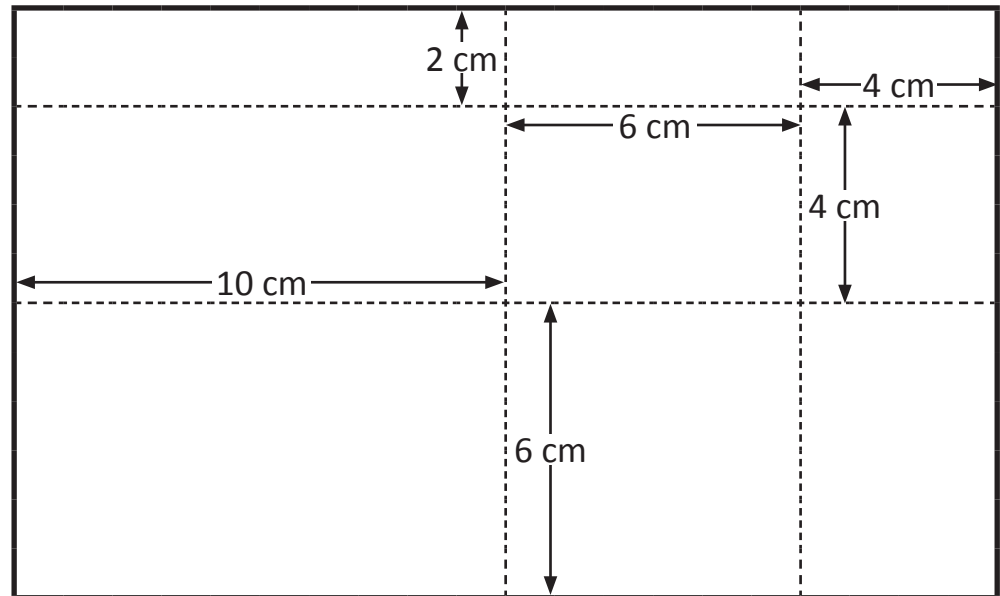

Perimeter =

Diagram 2

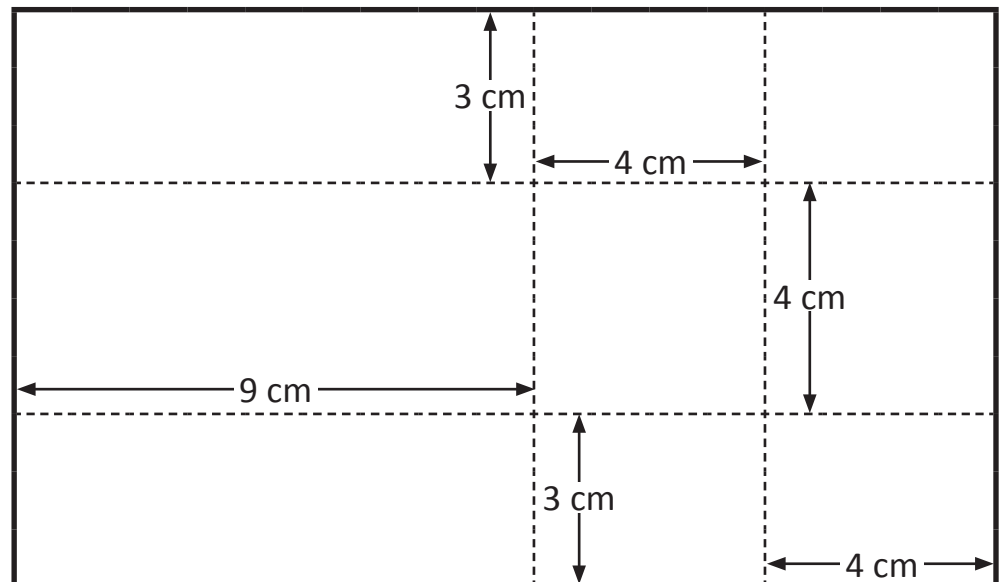

Perimeter =

Area – square centimetres

Area is the amount of space a shape covers. It is a 2D measurement. We measure area in square units. For small areas, we use square centimetres.

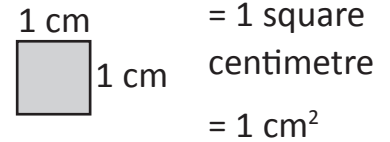

- 1 Each square covers an area of 1 square centimetre (1 cm²). Record the area of each shape:

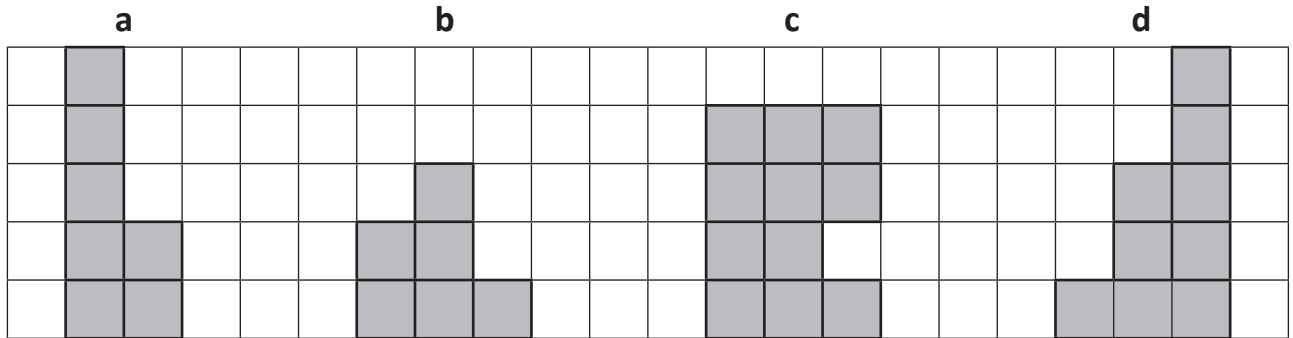

Area = ____ cm²

Area = ____ cm²

Area = ____ cm²

Area = ____ cm²

- 2 Find the area of these irregular shapes. Use the 1 cm grid paper as your guide:

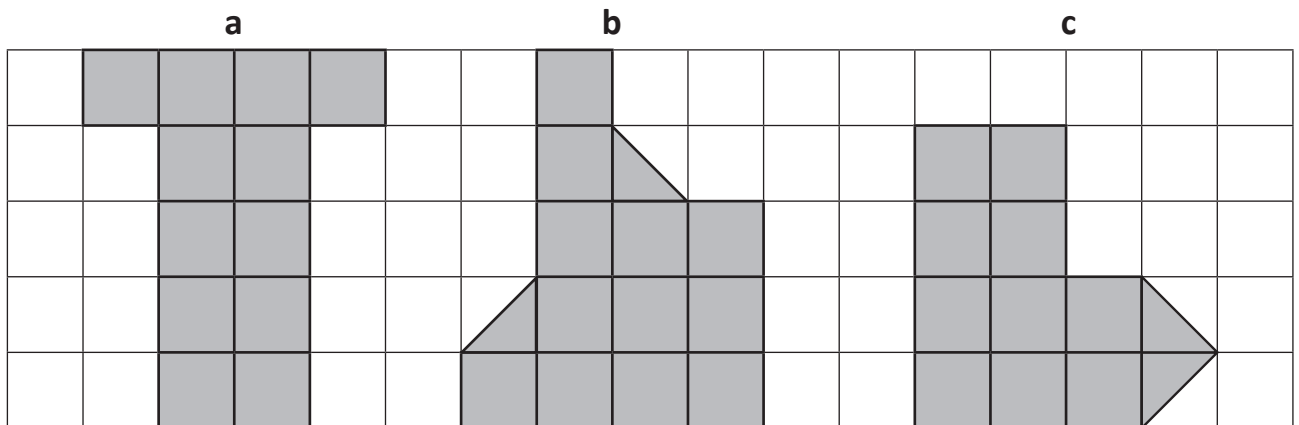

Area = ____ cm²

Area = ____ cm²

Area = ____ cm²

Area – square centimetres

- 3 Use the 1 square centimetre grid paper to shade some irregular shapes with the following areas:

a 4 square centimetres

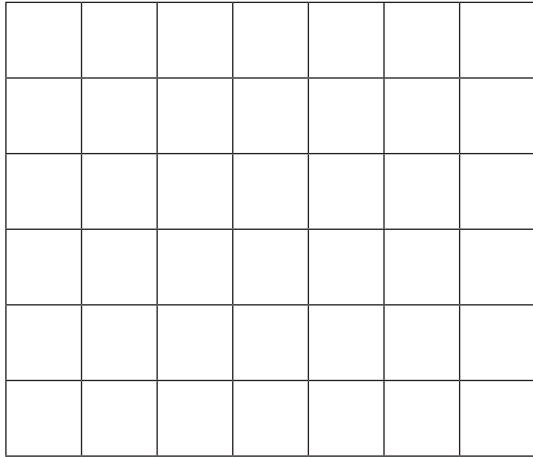

b 6 square centimetres

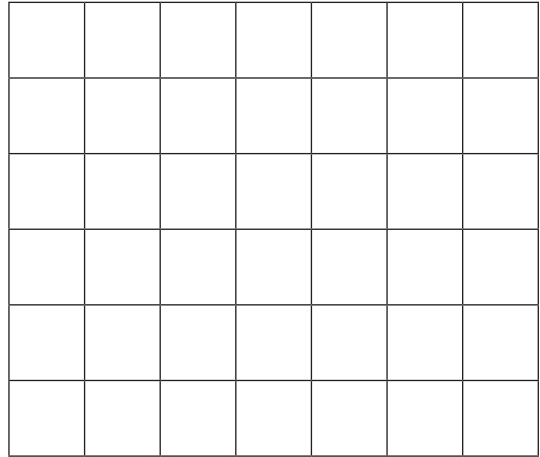

- 4 How many shapes can you make with an area of 9 square centimetres? Show them on the grid below. The first one has been done for you.

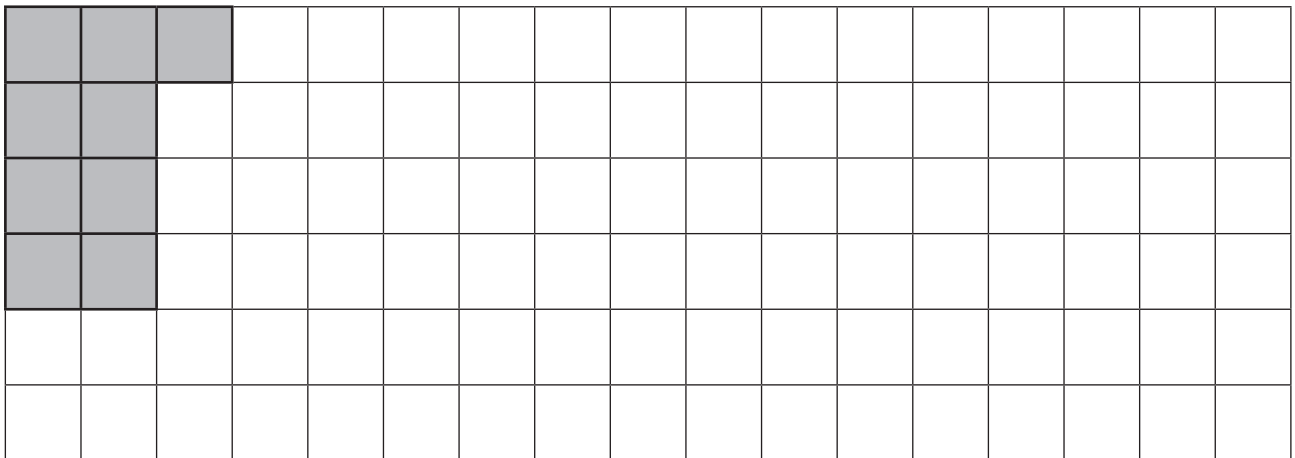

- 5 What is the area of each rectangle? Each square in the grid has an area of 1 cm².

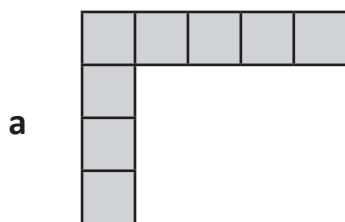

Area = _____

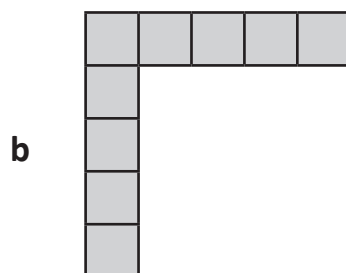

Area = _____

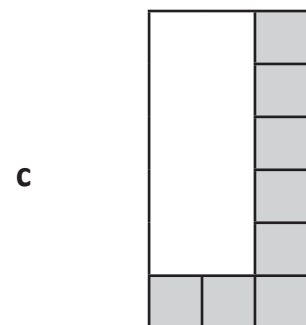

Area = _____

Area – square metres

When we need to find the areas of large spaces, we use square metres.
The symbol for square metres is m^2 .

1



In groups, stick pieces of newspaper together to make a square that is 1 metre long and 1 metre wide.

a How many people can fit standing inside one square metre?

b Cut your square into five pieces and then stick it back together. It can be any shape. Draw it here:

Is this still one square metre?

2

Use your square metre to measure five areas in your school. Estimate first.

Space to be measured	Estimate	Actual area
a		
b		
c		
d		
e		

Area – square metres

3 Rewrite these measurements the short way. The first one has been done for you.

a Twenty nine square metres =

b Thirty seven square metres =

c Three hundred and two square metres =

d Six hundred and ninety one square metres =

e Eighty point seven square metres =

f Seven point two square metres =

4 Miss Farbio has a rectangular garden with six fence posts. The distance between each post is 1 metre and the area of her garden is 2 m².

Her neighbour Mr Gubbio has 14 fence posts, also 1 metre apart. What is the area of his garden in square metres if one side of the fence has three posts, just like Miss Farbio's garden?

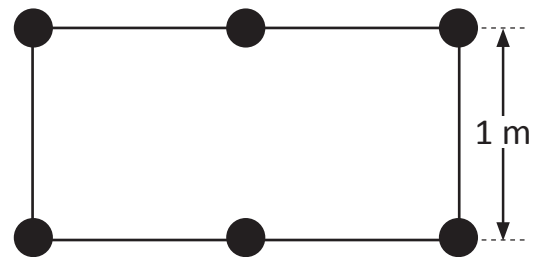

Area of Mr Gubbio's garden = _____

Area – investigating area and perimeter

1 What is the area and perimeter of these shapes?

a

P = _____
A = _____

b

P = _____
A = _____

c

P = _____
A = _____

d

P = _____
A = _____

1 cm

1 cm

2 Use the grid below to draw two shapes with a perimeter of 12 cm but with different areas:

1 cm

1 cm

3 Colour a square with a side length of 4 cm. Label its area and perimeter. Now colour a square with a side length of 5 cm and label its area and perimeter.

What do you notice? _____

Area – investigating area and perimeter

- 4 Look at this 1 cm square grid. Some of the grid is shaded. Work out the area of the part that is shaded.

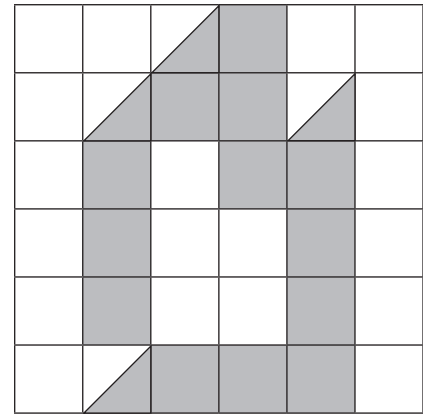

The area of the part that is shaded is cm²

A faster way to calculate area is to multiply the length by the width.

Look at this square. If we multiply the length by the width, we get 16 cm². This is the same as counting all the squares.

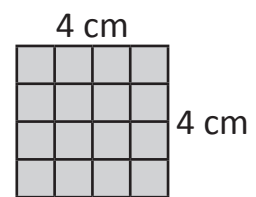

- 5 Calculate the area of each of these shapes by multiplying the length by the width:

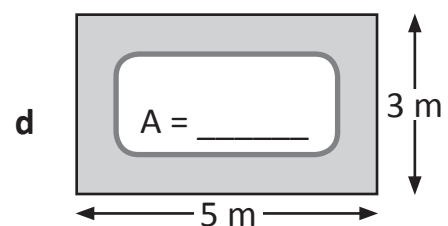
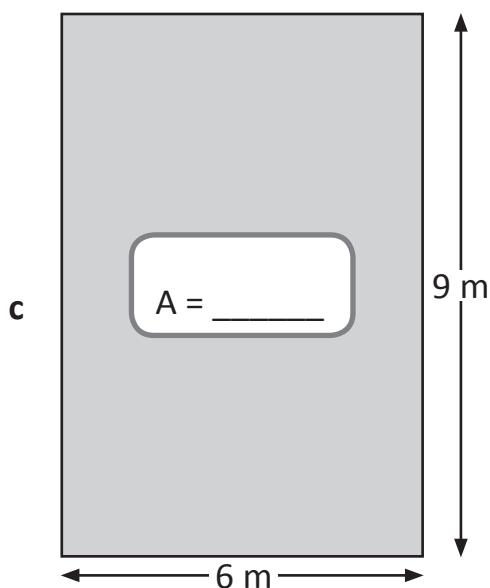
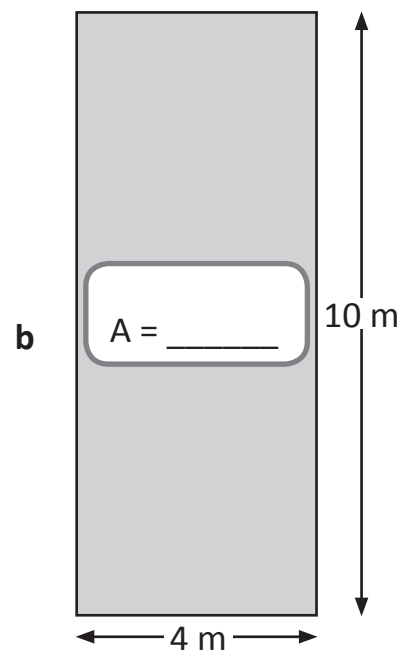
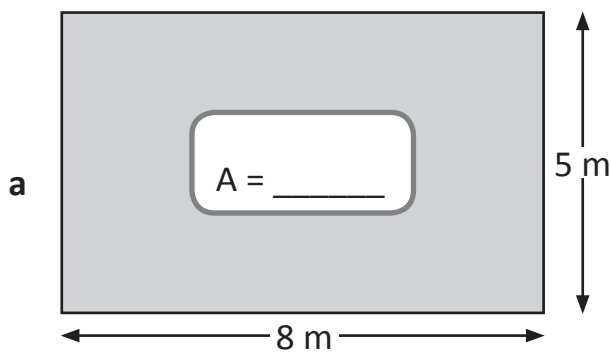



What to do



Solve these area challenges based on the dimensions:

- a A framed photograph is 16 cm × 25 cm. The frame itself is 5 cm wide. Use these clues to find the area of the photograph inside the frame.

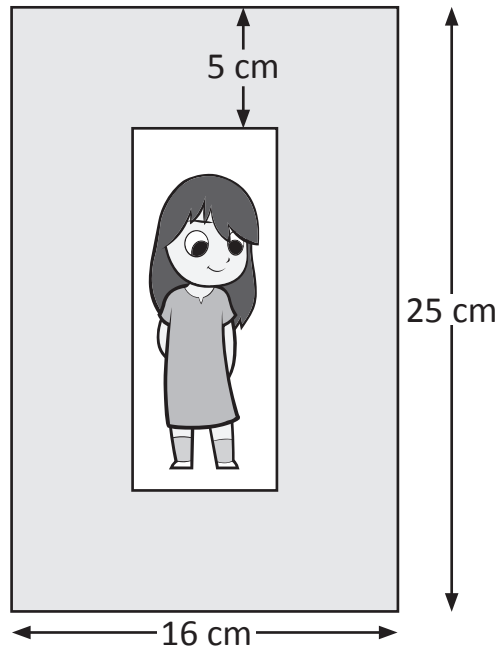

The area of the photograph is _____ cm².

- b Using a ruler, copy this shape so it reflects on the right of the mirror line. Then work out the total area of this shape.

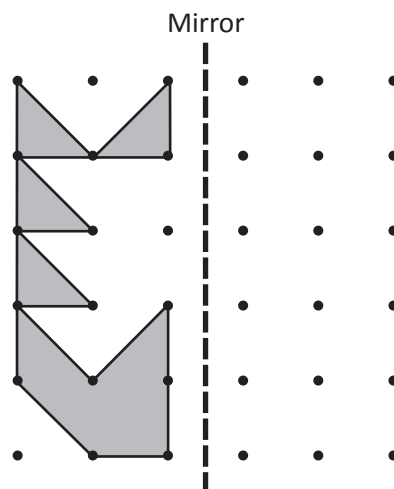

The total area of this shape is _____ cm².



Solve these area challenges based on the dimensions:

- a Max folded a rectangular piece of paper in half three times to make a square. If one side of the final square was 2 cm, what was the area of the piece of paper he started with?

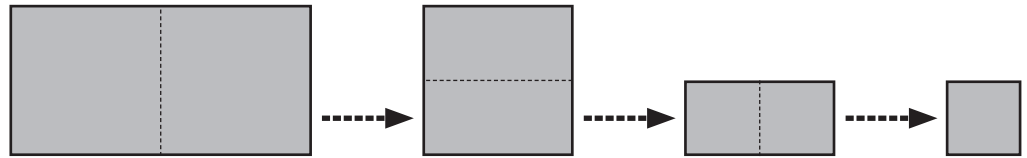

The area of the piece of paper he started with was _____ cm².

.....

- b Amber received a drawing from her cousin Cameron. The drawing was on a square piece of paper folded in half four times. If the area of the folded drawing was 4 cm², what was the area of the original piece of paper that Cameron drew on?

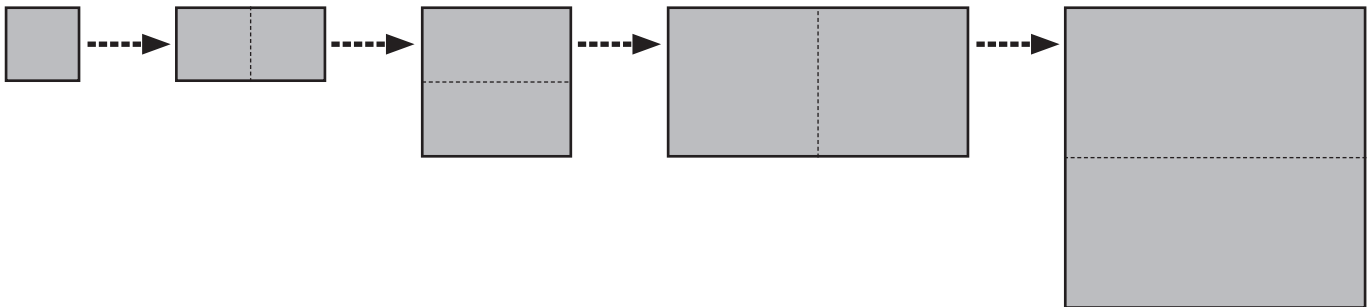

The area of the original piece of paper that Cameron drew on was _____ cm².